



# ***RX-V420RDS***

---

*Natural Sound AV Receiver*  
*Ampli-tuner audio-vidéo*

OWNER'S MANUAL  
MODE D'EMPLOI  
BEDIENUNGSANLEITUNG  
BRUKSANVISNING  
MANUALE DI ISTRUZIONI  
MANUAL DE INSTRUCCIONES  
GEBRUIKSAANWIJZING

# CAUTION: READ THIS BEFORE OPERATING YOUR UNIT.

- 1 To assure the finest performance, please read this manual carefully. Keep it in a safe place for future reference.
- 2 Install this unit in a well ventilated, cool, dry, clean place with at least 30 cm on the top, 20 cm on the right and left, and 10 cm at the back of this unit for ventilation space — away from direct sunlight, heat sources, vibration, dust, moisture, and/or cold.
- 3 Locate this unit away from other electrical appliances, motors, or transformers to avoid humming sounds. To prevent fire or electrical shock, do not place this unit where it may get exposed to rain, water, and/or any type of liquid.
- 4 Do not expose this unit to sudden temperature changes from cold to hot, and do not locate this unit in a environment with high humidity (i.e. a room with a humidifier) to prevent condensation inside this unit, which may cause an electrical shock, fire, damage to this unit, and/or personal injury.
- 5 On the top of this unit, do not place:
  - Other components, as they may cause damage and/or discoloration on the surface of this unit.
  - Burning objects (i.e. candles), as they may cause fire, damage to this unit, and/or personal injury.
  - Containers with liquid in them, as they may cause electrical shock to the user and/or damage to this unit.
- 6 Do not cover this unit with a newspaper, tablecloth, curtain, etc. in order not to obstruct heat radiation. If the temperature inside this unit rises, it may cause fire, damage to this unit, and/or personal injury.
- 7 Do not plug in this unit to a wall outlet until all connections are complete.
- 8 Do not operate this unit upside-down. It may overheat, possibly causing damage.
- 9 Do not use force on switches, knobs and/or cords.
- 10 When disconnecting the power cord from the wall outlet, grasp the plug; do not pull the cord.
- 11 Do not clean this unit with chemical solvents; this might damage the finish. Use a clean, dry cloth.
- 12 Only voltage specified on this unit must be used. Using this unit with a higher voltage than specified is dangerous and may cause fire, damage to this unit, and/or personal injury. YAMAHA will not be held responsible for any damage resulting from use of this unit with a voltage other than specified.
- 13 To prevent damage by lightning, disconnect the power cord from the wall outlet during an electrical storm.
- 14 Take care of this unit so that no foreign objects and/or liquid drops inside this unit.
- 15 Do not attempt to modify or fix this unit. Contact qualified YAMAHA service personnel when any service is needed. The cabinet should never be opened for any reasons.
- 16 When not planning to use this unit for long periods of time (i.e. vacation), disconnect the AC power plug from the wall outlet.
- 17 Be sure to read the “TROUBLESHOOTING” section on common operating errors before concluding that this unit is faulty.
- 18 Before moving this unit, press **STANDBY/ON** to set this unit in the standby mode, and disconnect the AC power plug from the wall outlet.

This unit is not disconnected from the AC power source as long as it is connected to the wall outlet, even if this unit itself is turned off. This state is called the standby mode. In this state, this unit is designed to consume a very small quantity of power.

## ■ For U.K. customers

If the socket outlets in the home are not suitable for the plug supplied with this appliance, it should be cut off and an appropriate 3 pin plug fitted. For details, refer to the instructions described below.

### Note

- The plug severed from the mains lead must be destroyed, as a plug with bared flexible cord is hazardous if engaged in a live socket outlet.

## ■ Special Instructions for U.K. Model

### IMPORTANT

THE WIRES IN MAINS LEAD ARE COLOURED IN ACCORDANCE WITH THE FOLLOWING CODE:

Blue: NEUTRAL

Brown: LIVE

As the colours of the wires in the mains lead of this apparatus may not correspond with the coloured markings identifying the terminals in your plug, proceed as follows:

The wire which is coloured BLUE must be connected to the terminal which is marked with the letter N or coloured BLACK. The wire which is coloured BROWN must be connected to the terminal which is marked with the letter L or coloured RED.

Making sure that neither core is connected to the earth terminal of the three pin plug.



# CONTENTS

## INTRODUCTION

<b>FEATURES</b> .....	<b>2</b>
<b>GETTING STARTED</b> .....	<b>3</b>
Checking the Package Contents .....	3
Battery Installation in the Remote Control .....	3
Battery Replacement .....	3
<b>CONTROLS AND FUNCTIONS</b> .....	<b>4</b>
Front Panel .....	4
Remote Control .....	6
Using the Remote Control .....	7
Display .....	8
Rear Panel .....	9

## PREPARATION

<b>SPEAKER SETUP</b> .....	<b>10</b>
Speakers to Be Used .....	10
Speaker Placement .....	10
<b>CONNECTIONS</b> .....	<b>11</b>
Before Connecting Components .....	11
Connecting Audio Components .....	12
Connecting an External Decoder .....	12
Connecting Video Components .....	14
Connecting Speakers .....	16
IMPEDANCE SELECTOR Switch .....	18
Connecting the Power Supply Cords .....	18
<b>ADJUSTING THE SPEAKER BALANCE</b> ....	<b>19</b>
Before You Start Adjusting .....	19
Using the Test Tone .....	19

## BASIC OPERATION

<b>PLAYING A SOURCE</b> .....	<b>21</b>
Input Modes and Indications .....	23
Selecting a DSP Program .....	24
Canceling the Sound Effect (turning off the effect speakers) .....	25
<b>TUNING</b> .....	<b>26</b>
Connecting the Antennas .....	26
Automatic Tuning .....	27
Manual Tuning .....	27
Automatic Preset Tuning (for RDS stations only) .....	28
Manual Preset Tuning .....	29
To Recall a Preset Station .....	29
Exchanging Preset Stations .....	30
<b>RECEIVING RDS STATIONS</b> .....	<b>31</b>
Description of RDS Data .....	31
Changing the RDS Mode .....	31
PTY SEEK Function .....	32
EON Function .....	33
<b>RECORDING A SOURCE</b> .....	<b>34</b>

## ADVANCED OPERATION

<b>SET MENU</b> .....	<b>35</b>
Adjusting the Items on the SET MENU .....	35
1 SPEAKER SET (speaker mode settings) .....	36
2 HP TONE CTRL (headphone tone control) .....	37
3 I/O ASSIGN .....	38
4 INPUT MODE (initial input mode) .....	38
5 DOLBY D. SET (Dolby Digital set) .....	38
6 DTS SET (DTS LFE level) .....	39
7 SP DLY TIME (center delay) .....	39
8 DIPSLAY SET .....	39
9 MEM. GUARD (memory guard) .....	39
<b>DELAY TIME AND SPEAKER OUTPUT LEVELS</b> .....	<b>40</b>
Delay Time .....	40
Sound Output Level of the Center, Right Rear and Left Rear Speakers, and Subwoofer .....	40
Adjusting Method .....	41
<b>SLEEP TIMER</b> .....	<b>42</b>
Setting the SLEEP Timer .....	42
Canceling the SLEEP Timer .....	42
<b>SOUND FIELD PROGRAM</b> .....	<b>43</b>
Hi-Fi DSP Programs .....	43
CINEMA DSP Programs .....	43

## APPENDIX

<b>TROUBLESHOOTING</b> .....	<b>46</b>
<b>SPECIFICATIONS</b> .....	<b>50</b>
<b>GLOSSARY</b> .....	<b>51</b>
<b>INDEX</b> .....	<b>53</b>



## FEATURES

### 5-Channel Power Amplification

- ◆ Minimum RMS Output  
(0.06% THD, 20 Hz – 20 kHz)  
Main: 65 W + 65 W (8 Ω)  
Center: 65 W (8 Ω)  
Rear: 65 W + 65 W (8 Ω)

### Multi-mode Digital Sound Field Processing

- ◆ DTS Decoder
- ◆ Dolby Pro Logic Decoder
- ◆ Dolby Digital Decoder
- ◆ Hi-Fi DSP
- ◆ CINEMA DSP: Combination of YAMAHA DSP Technology and Dolby Digital, Dolby Pro Logic or DTS
- ◆ Virtual CINEMA DSP
- ◆ SILENT CINEMA

### Sophisticated FM/AM Tuner

- ◆ 40-Station Random Access Preset Tuning
- ◆ Automatic Preset Tuning
- ◆ Preset Station Shifting Capability (Preset Editing)
- ◆ Multi-Functions for RDS Broadcast Reception

### Other Features

- ◆ “SET MENU” which Provides You with 9 Items for Optimizing This Unit for Your Audio/Video System
- ◆ Test Tone Generator for Easier Speaker Balance Adjustment
- ◆ 6-Channel External Decoder Input for Other Future Formats
- ◆ Video Signal Input and Output Capability
- ◆ Optical and Coaxial Digital Signal Input Jacks
- ◆ SLEEP Timer
- ◆ Remote Control Capability

- ☀ indicates a tip for your operation.
- Some operations can be performed by using either the buttons on the main unit or on the remote control. In cases when the button names differ between the main unit and the remote control, the button name on the remote control is given in parentheses in this manual.



Manufactured under license from Dolby Laboratories.

“Dolby”, “AC-3”, “Pro Logic” and the double-D symbol are trademarks of Dolby Laboratories.  
Confidential Unpublished Works. ©1992-1997 Dolby Laboratories, Inc. All rights reserved.



Manufactured under license from Digital Theater Systems, Inc. US Pat. No. 5,451,942 and other world-wide patents issued and pending. “DTS” and “DTS Digital Surround” are trademarks of Digital Theater Systems, Inc. Copyright 1996 Digital Theater Systems, Inc. All Rights Reserved.



# GETTING STARTED

## Checking the Package Contents

Check that the following items are included in your package.

### Remote control

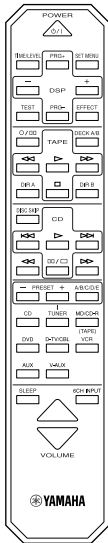

### Batteries (AA, R06, UM-3 type)

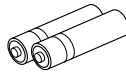

### AM loop antenna



### Indoor FM antenna

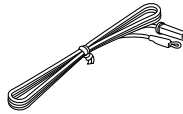

### Connection guide

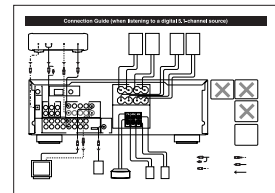

### 75-ohm/300-ohm antenna adapter (U.K. model only)

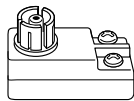

## Battery Installation in the Remote Control

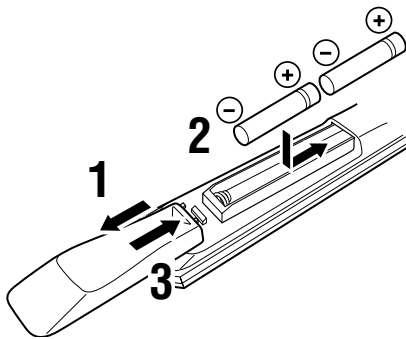

## Battery Replacement

If the remote control operates only when it is close to the unit, the batteries are weak. Replace all the batteries with new ones.

### Notes

- Use only AA, R06 or UM-3 batteries for replacement.
- Be sure the battery polarity is correct. (See the illustration inside the battery compartment.)
- Remove the batteries if the remote control will not be used for an extended period of time.
- If the batteries have leaked, dispose of them immediately. Avoid touching the leaked material or letting it come into contact with clothing, etc. Clean the battery compartment thoroughly before installing new batteries.

- 1** Turn the remote control over and slide the battery compartment cover in the direction of the arrow.
- 2** Insert the batteries (AA, R06 or UM-3 type) according to the polarity markings on the inside of the battery compartment.
- 3** Close the battery compartment cover.



# CONTROLS AND FUNCTIONS

## Front Panel

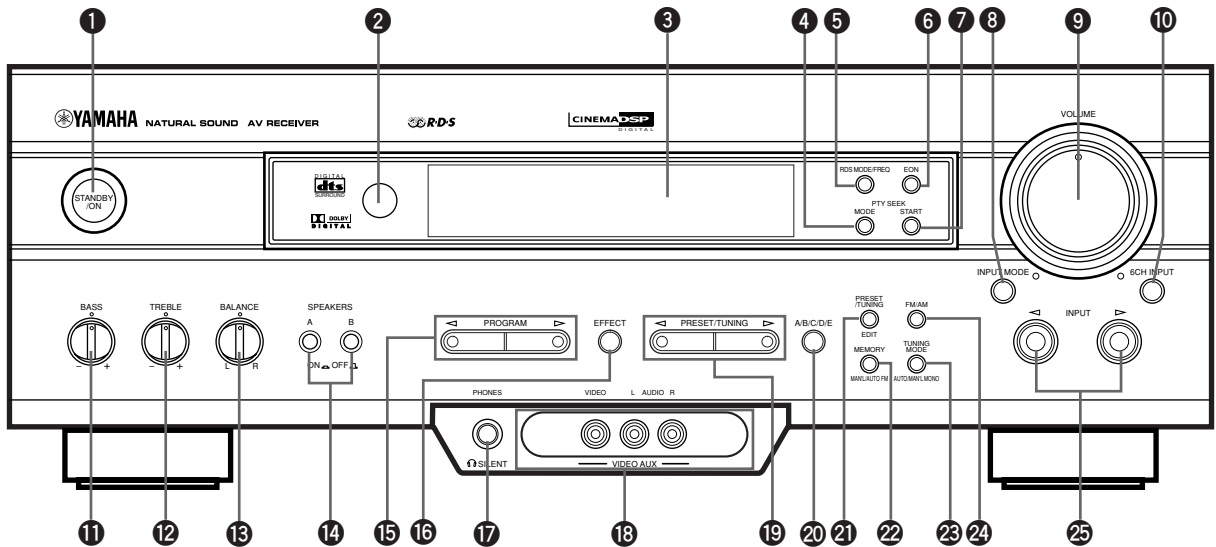

### 1 STANDBY/ON

Press this switch to turn on the power of this unit or to set this unit in the standby mode. Before turning the power on, set the volume at the minimum level.

#### Standby mode

In this mode, this unit consumes a very small quantity of power to receive infrared-signals from the remote control.

### 2 Remote control sensor

This receives signals from the remote control.

### 3 Display

This shows various information.

### 4 PTY SEEK MODE

Press this button to set the unit in the PTY SEEK mode.

### 5 RDS MODE/FREQ

When an RDS station is received, press this button to change the display mode among the PS mode, PTY mode, RT mode, CT mode (if the station offers those RDS data services) and/or frequency display mode in turn.

### 6 EON

Press this button to select the desired program type (NEWS, INFO, AFFAIRS, SPORT) when you want to tune in to a radio program of that type automatically.

### 7 PTY SEEK START

Press this button to begin searching for a station after the desired program type has been selected in the PTY SEEK mode.

### 8 INPUT MODE

Press this button to select the input mode among AUTO, DTS and ANALOG for the sources that send two or more types of signals to this unit.

### 9 VOLUME

Turn this control to turn up or down the volume.

### 10 6CH INPUT

Press this button to select the source connected to the 6CH INPUT jacks. The source selected by pressing 6CH INPUT takes priority over the source selected with INPUT </> (or the input selector buttons on the remote control).

**11 BASS**

Turn this control clockwise to increase or counterclockwise to decrease the low-frequency response.

**12 TREBLE**

Turn this control clockwise to increase or counterclockwise to decrease the high-frequency response.

**Note**

- If you increase or decrease the high-frequency or the low-frequency sound to an extreme level, the tonal quality from the center and rear speakers may not match that of the left and right main speakers.

**13 BALANCE**

This control is only effective for the sound from the main speakers.

Turn the control to adjust the balance of the output volume from the right and left main speakers to compensate for sound imbalance caused by the speaker location or listening room conditions.

**14 SPEAKERS A/B**

Set A or B (or both A and B) to the ON position for the main speaker system (connected to this unit) that you want to use. Set the button(s) to the OFF position for the main speaker system that you don't want to use.

**15 PROGRAM </>**

Press < or > to select a DSP program when the effect speakers (center and rear) are turned on. The name of the selected program appears on the display.

**16 EFFECT**

Press this button to turn on or off the effect speakers (center and rear). If you turn them off, all Dolby Digital and DTS audio signals except for the LFE channel are directed to the right and left main speakers. In that case, the output levels of the right and left speakers may not match.

**17 PHONES jack**

Connect the headphones to the PHONES jack so that this unit outputs audio signals for private listening.

When listening with headphones privately, set both SPEAKERS A/B to the OFF position.

**18 VIDEO AUX jacks**

Connect an auxiliary audio or video input source such as a game console to these jacks. To reproduce source signals from these jacks, select V-AUX as the input source.

**19 PRESET/TUNING </>**

When “>” appears on the display:

This button is used to select a preset station number (1 to 8). Press < to select a lower and > to select a higher preset station number.

When “>” goes off from the display:

This button is used for tuning. Press < to tune in to lower frequencies, and > to tune in to higher frequencies.

When this unit is in the PTY SEEK mode, press this button to select a program type.

**20 A/B/C/D/E**

Press this button to select one of 5 preset station groups (A to E).

**21 PRESET/TUNING (EDIT)**

Press this button to turn on or off “>” on the display and switch the function between for storing a broadcasting station (preset tuning) and for tuning. This button is also used to exchange the assignment of two preset stations with each other.

**22 MEMORY (MAN'L/AUTO FM)**

Press this button to store the broadcasting stations. Hold down this button for more than 3 seconds to begin automatic preset tuning (for FM stations only).

**23 TUNING MODE (AUTO/MAN'L MONO)**

Press this button to switch the tuning mode between automatic and manual. To use the automatic tuning method, press this button so that the “AUTO” indicator lights up on the display. To use the manual tuning method, press this button so that the “AUTO” indicator goes off.

**24 FM/AM**

Press this button to switch the reception band between FM and AM.

**25 INPUT </>**

Press these buttons to select the input source (DVD, AUX, MD/CD-R, TUNER, CD, V-AUX, VCR, D-TV/CBL) that you want to listen to or watch. The name of the selected input source appears on the display.

## Remote Control

The provided remote control is designed to control all most commonly used functions of this unit. If a YAMAHA tape deck or CD player designed for remote control compatibility is connected to this unit, this remote control can also control various functions of that component.

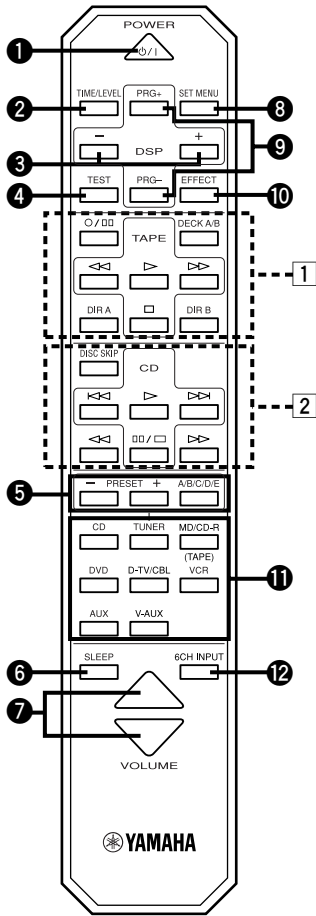

### ■ Controlling this unit

#### ❶ POWER

Each time you press this button, the unit switches between the power on and standby mode.

#### ❷ TIME/LEVEL

Press this button to select the item in the TIME/LEVEL mode.

#### ❸ -/+

These buttons adjust the settings of the SET MENU and TIME/LEVEL mode.

#### ❹ TEST

Press this button to output the test tone for each speaker.

#### ❺ A/B/C/D/E, PRESET +/-

These buttons are used to select a preset station.

A/B/C/D/E: To select one of a group (A to E) of preset stations

PRESET +/-: To select a preset station number (1 to 8)

#### ❻ SLEEP

Press this button to set the SLEEP timer.

#### ❼ VOLUME

These buttons are used to adjust the volume level.

△ : To turn up the volume

▽ : To turn down the volume

#### ❽ SET MENU

Press this button to select the items in the SET MENU.

#### ❾ DSP PRG+, PRG-

Press these buttons to select a DSP program.

#### ❿ EFFECT

Press this button to turn on or off the effect speakers (center and rear).

#### ⓫ Input selector buttons

These buttons select the input source.

CD: To play a CD

TUNER: To listen to an FM (RDS) or AM broadcast

MD/CD-R(TAPE): To play an MD or CD recorder (or tape deck)

DVD: To play a DVD

D-TV/CBL: To watch a TV/digital TV or cable TV

VCR: To play a video cassette

AUX: To use another audio component

V-AUX: To use another audio/video component

#### ⓬ 6CH INPUT

Press this button to play a source connected to the 6CH INPUT jacks.



## Using the Remote Control

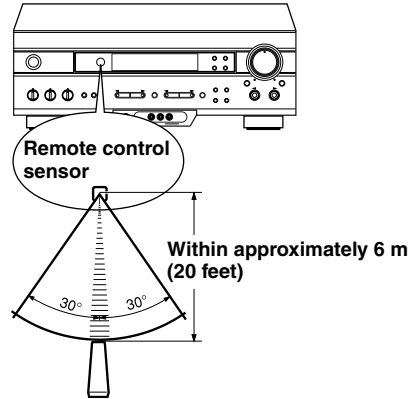

The remote control transmits a directional infrared beam. Be sure to aim the remote control directly at the infrared sensor during operation. When the sensor is covered or there is a large object between the remote control and the sensor, the sensor cannot receive signals. The sensor may not be able to receive signals properly when it is exposed to direct sunlight or a strong artificial light (such as a fluorescent or strobe light). In this case, change the direction of the light or reposition the unit to avoid direct lighting.

### Notes

- Handle the remote control with care.
- Do not spill water, tea or other liquids on the remote control.
- Do not drop the remote control.
- Do not leave or store the remote control in the following conditions:
  - high humidity or temperature such as near a heater, stove or bath;
  - dusty places; or
  - extremely low temperature.

## Controlling a YAMAHA tape deck or CD player

Identify the remote control buttons with your component's buttons. If these buttons are identical, their functions will be the same. Refer to the instructions for each button function supplied with your component.

### 1 Tape deck buttons

These buttons are used for controlling a tape deck.

- DECK A/B, DIR A and DIR B are only available for a double cassette tape deck.
- For a single cassette tape deck with an automatic reverse function, press DIR A to reverse the direction of tape running.

### 2 CD player buttons

These buttons are used for controlling a CD player.

- DISC SKIP is only available for a CD player with a CD changer.

## Display

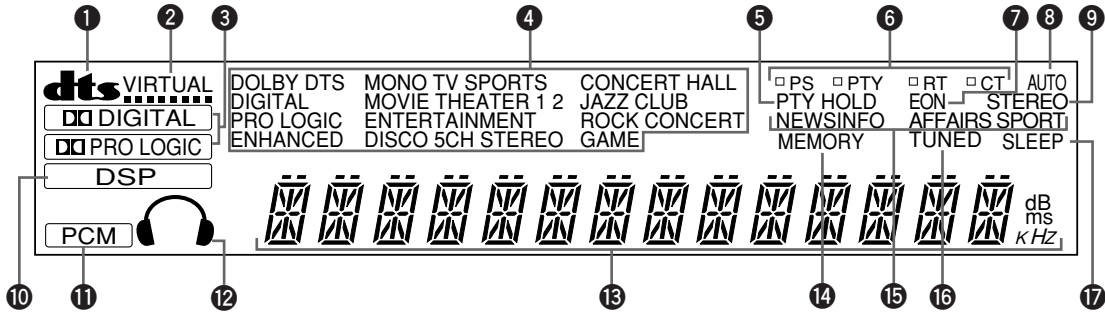

### 1 **dts** indicator

The “**dts**” indicator lights up when the built-in DTS decoder is turned on.

### 2 **VIRTUAL** indicator

This lights up when using Virtual CINEMA DSP.

### 3 **DIGITAL** and **PRO LOGIC** indicators

“**DIGITAL**” lights up when the built-in Dolby Digital decoder is on and the signals of the selected source are encoded with Dolby Digital. “**PRO LOGIC**” lights up when the built-in Dolby Pro Logic decoder is on.

### 4 **DSP** program indicators

This indicates the name of the selected DSP program.

### 5 **PTY HOLD** indicator

This lights up while searching for stations in the PTY SEEK mode.

### 6 **RDS mode indicators**

The name(s) of the RDS data offered by the currently received RDS station light(s) up. Illumination of the red indicator next to the RDS data name shows that the corresponding RDS mode is now selected.

### 7 **EON** indicator

This lights up when an RDS station that offers the EON data service is being received.

### 8 **AUTO** indicator

This lights up when the unit is in the automatic tuning mode.

### 9 **STEREO** indicator

This lights up when an FM stereo broadcast with sufficient signal strength is being received.

### 10 **DSP** indicator

“**DSP**” lights up when the built-in digital sound field processor is on.

### 11 **PCM** indicator

This lights up when this unit is reproducing PCM (pulse code modulation) digital audio signals.

### 12 **Headphones** indicator

This lights up when headphones are connected.

### 13 **Multi-information display**

This display shows various information: for example the name of the selected input source and the various settings during adjustment with the SET MENU. The current station frequency and band (FM or AM) also appear when the tuner is selected as the input source.

### 14 **MEMORY** indicator

This flashes for about 5 seconds after pressing MEMORY. During this period, the displayed station can be stored in the memory.

### 15 **Program type name indicators**

The name of the selected program type lights up when the “EON” indicator lights up.

### 16 **TUNED** indicator

This lights up when this unit tunes in to a station.

### 17 **SLEEP** indicator

This lights up while the built-in SLEEP timer is on.

## Rear Panel

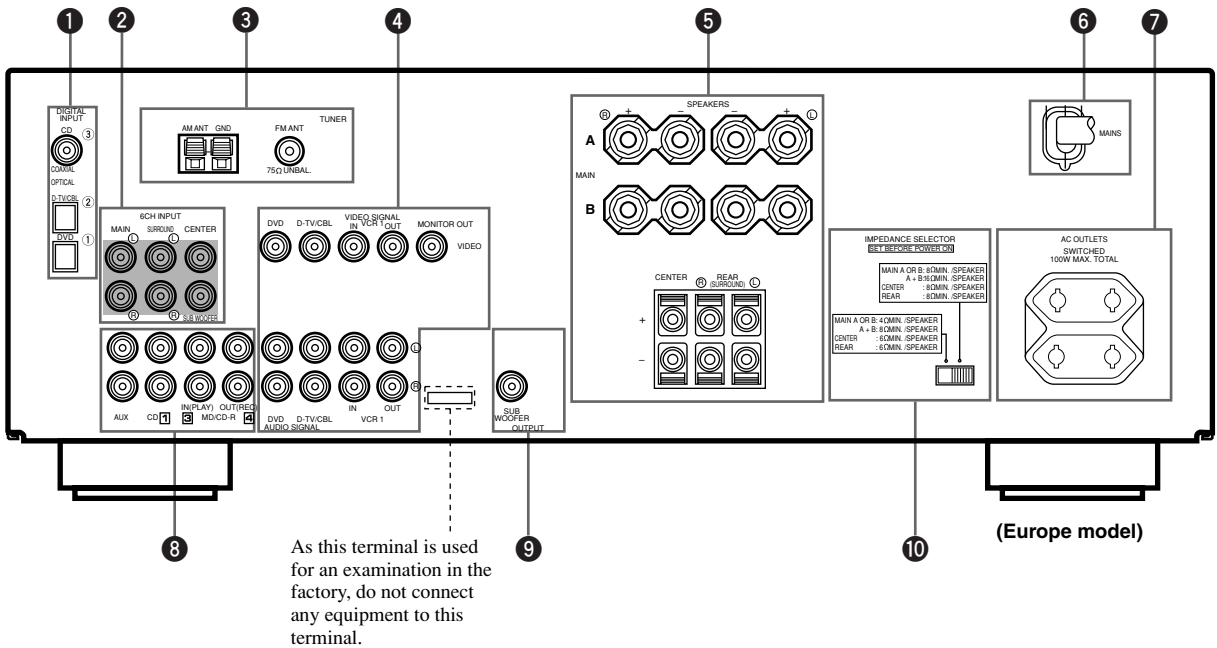
**1 DIGITAL INPUT jacks****2 6CH INPUT jacks**

See pages 12 and 13 for connection information.

**3 Antenna input terminals**

See page 26 for connection information.

**4 Video component jacks**

See pages 14 and 15 for connection information.

**5 Speaker terminals**

See pages 16 and 17 for connection information.

**6 AC power cord**

Connect to a power outlet.

**7 AC OUTLET(S)**

Use these outlets to supply power to your other audio/video components (see page 18).

**8 Audio component jacks**

See pages 12 and 13 for connection information.

**9 SUBWOOFER jack**

See page 17 for connection information.

**10 IMPEDANCE SELECTOR switch**

Use this switch to match the amplifier output to your speaker impedance. Set this unit in the standby mode before you change the setting of this switch (see page 18).



# SPEAKER SETUP

## Speakers to Be Used

This unit is designed to provide the best sound-field quality with a 5-speaker system, using main speakers, rear speakers and a center speaker. If you use different brands of speakers (with different tonal qualities) in your system, the tone of a moving human voice and other types of sound may not shift smoothly. We recommend that you use speakers from the same manufacture to ensure even tonal quality.

The main speakers are used for the main source sound plus the effect sounds. They will probably be the speakers from your present stereo system. The rear speakers are used for the effect and surround sounds, and the center speaker is for the center sounds (dialog, vocals, etc.). If for some reason it is not practical to use a center speaker, you can do without it. Best results, however, are obtained with the full system.

The main speakers should be high-performance models and have enough power-handling capacity to accept the maximum output of your audio system. The other speakers do not have to be equal to the main speakers. For precise sound localization, however, it is ideal to use high-performance models that can reproduce sounds over the full range for the center speaker and the rear speakers.

### ■ Use of a subwoofer expands your sound field

It is also possible to further expand your system with the addition of a subwoofer. The use of a subwoofer is effective not only for reinforcing bass frequencies from any or all channels, but also for reproducing the LFE (low frequency effect) channel with high fidelity when playing back a source encoded with Dolby Digital or DTS. The YAMAHA Active Servo Processing Subwoofer System is ideal for natural and lively bass reproduction.

## Speaker Placement

Refer to the following diagram when you place the speakers.

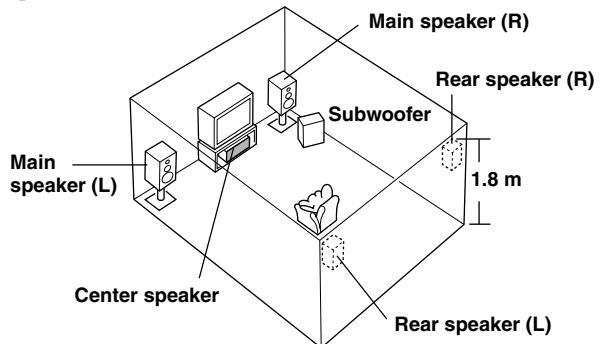

### ■ Main speakers

Place the right and left main speakers an equal distance from the ideal listening position. The distance of each speaker from each side of the TV monitor should be the same.

### ■ Rear speakers

Place these speakers behind your listening position, facing slightly inwards, nearly 1.8 m (approx. 6 feet) above the floor.

### ■ Center speaker

Align the front face of the center speaker with the front face of your TV monitor. Place the speaker as close to the monitor as possible, such as directly over or under the monitor and centrally between the main speakers.

#### Note

- If the center speaker is not used, the sound will be heard from the right and left main speakers. In that case, "CENTER SP" in the SET MENU is set to the NON position.

### ■ Subwoofer

The position of the subwoofer is not so critical, because low bass sounds are not highly directional. But it is better to place the subwoofer near the main speakers. Turn it slightly toward the center of the room to reduce the wall reflections.

#### CAUTION

Please use magnetically shielded speakers. Sometimes a video monitor may be adversely affected even when magnetically shielded speakers are used. Separate the speakers from the monitor if this happens.



# CONNECTIONS

## Before Connecting Components

### CAUTION

Never connect this unit and other components to mains power until all connections between components have been completed.

Be sure all connections are made correctly, that is to say L (left) to L, R (right) to R, “+” to “+” and “-” to “-”. Some components require different connection methods and have different jack names. Refer to the instructions for each component to be connected to this unit.

When you connect other YAMAHA audio components (such as a tape deck, MD recorder and CD player or changer), connect it to the jacks with the same number labels as **1**, **3**, **4** etc.

Use RCA-type pin plug cables for connecting audio/video components with the exception described later.

The input and output jacks for pin plugs can be distinguished as follows:

Yellow	video signals (composite)	
White	analog audio signals for the left channel	
Red	analog audio signals for the right channel	
	coaxial digital signals	

After completing all connections, check them again to make sure they are correct.

## Connecting Audio Components

### ■ Connecting to digital jacks

This unit has digital jacks for direct transmission of digital signals through either coaxial or fiber optic cables. You can use the digital jacks to input PCM, Dolby Digital and DTS bitstreams. When you connect components to both the COAXIAL and OPTICAL jacks, priority is given to the input signals from the COAXIAL jack.



- You can designate the input for each digital jack according to your component by using “3 I/O ASSIGN” in the SET MENU.

#### Notes

- When making connections between the digital signal jacks, you should connect the components to the same-named analog audio signal jacks of this unit, because a digital signal cannot be recorded by a recording component connected to this unit.
- All digital signal input jacks are applicable to sampling frequencies of 32 kHz, 44.1 kHz and 48 kHz.

### About the dust protection cap



Pull out the cap from the optical jack before you connect the fiber optic cable. Do not discard the cap. When you are not using the optical jack, be sure to put the cap back in place. This cap protects the jack from dust.

#### Note

- The OPTICAL jacks on this unit conform to the EIA standard. If you use a fiber optic cable that does not conform to this standard, this unit may not function properly.

### ■ Connecting a CD player



- The COAXIAL jack is available for a CD player which has coaxial digital output jack.
- When you connect a CD player to both the analog and digital jacks, priority is given to the input signals from the digital jack.

### ■ Connecting an MD recorder, CD recorder or tape deck

Connect the analog input/output jack of your recording component to the AUDIO jacks.

#### Note

- When you connect a recording component to this unit, keep its power on while using this unit. If the power is off, this unit may distort the sound from other components.

## Connecting an External Decoder

This unit is equipped with 6 additional input jacks (left and right MAIN, CENTER, left and right SURROUND and SUBWOOFER) for discrete multi-channel input from an external decoder, sound processor or pre-amplifier.

Connect the output jacks on your external decoder to the 6CH INPUT jacks. Be sure to match the left and right outputs to the left and right input jacks for the main and surround channels.

#### Notes

- When you select 6CH INPUT as the input source, this unit automatically turns off the digital sound field processor, and you cannot listen to DSP programs.
- When you select 6CH INPUT as the input source, changing items of “1 SPEAKER SET” in the SET MENU is not affected (except “MAIN LVL”).

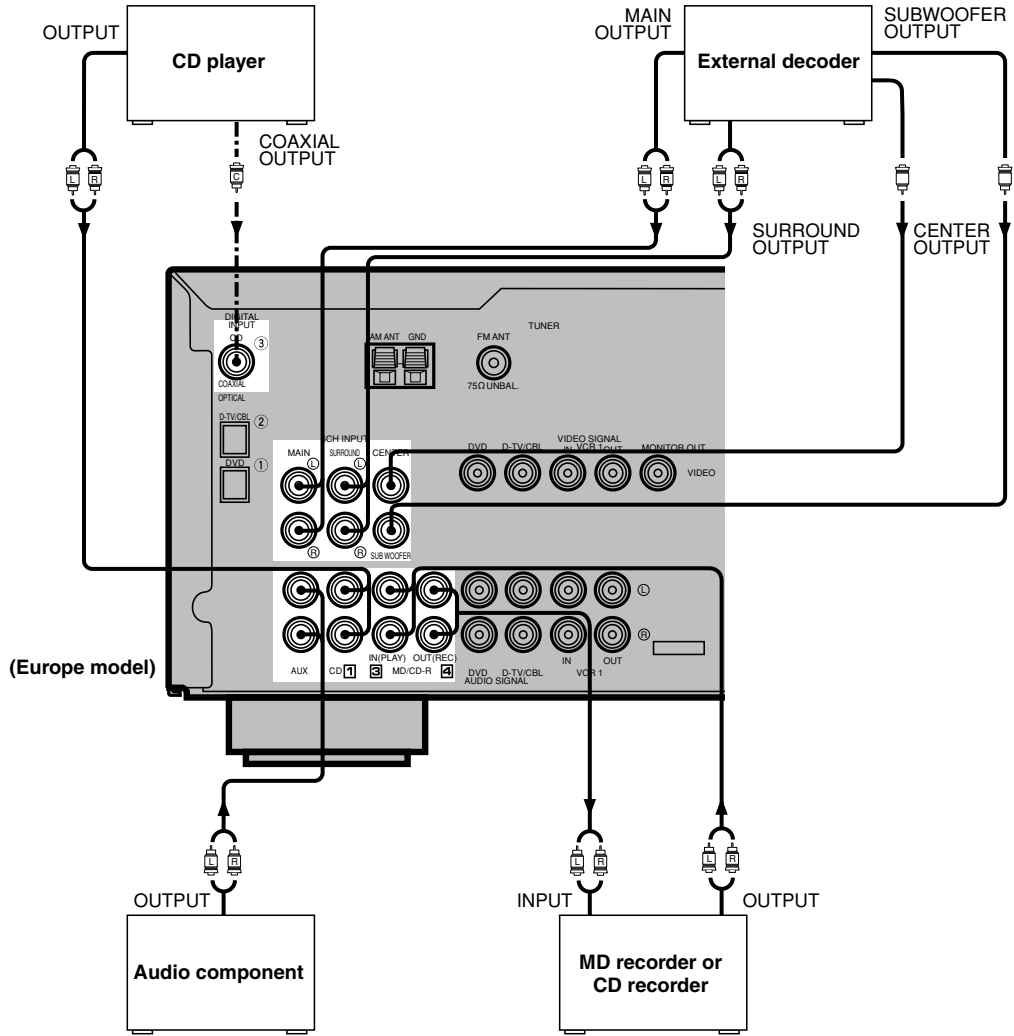

- indicates signal direction
- (L) — indicates left analog cables
- (R) — indicates right analog cables
- - - (C) - - - indicates coaxial cables

## Connecting Video Components

### ■ Audio signal jacks

Be sure to connect the right channel (R), left channel (L), input (IN) and output (OUT) properly.

### ■ Video signal jacks

Be sure to connect the input (IN) and output (OUT) properly.

### ■ TV monitor with a 21-pin connector

Make a connection as shown on page 15 with a commercially available SCART-plug connector cable.

### ■ VIDEO AUX jacks (on the front panel)

These jacks are used to connect any video input source such as a game console to this unit.

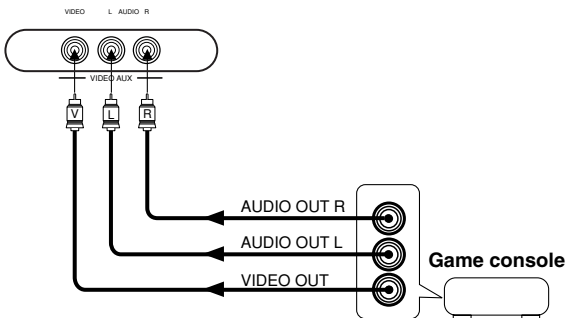



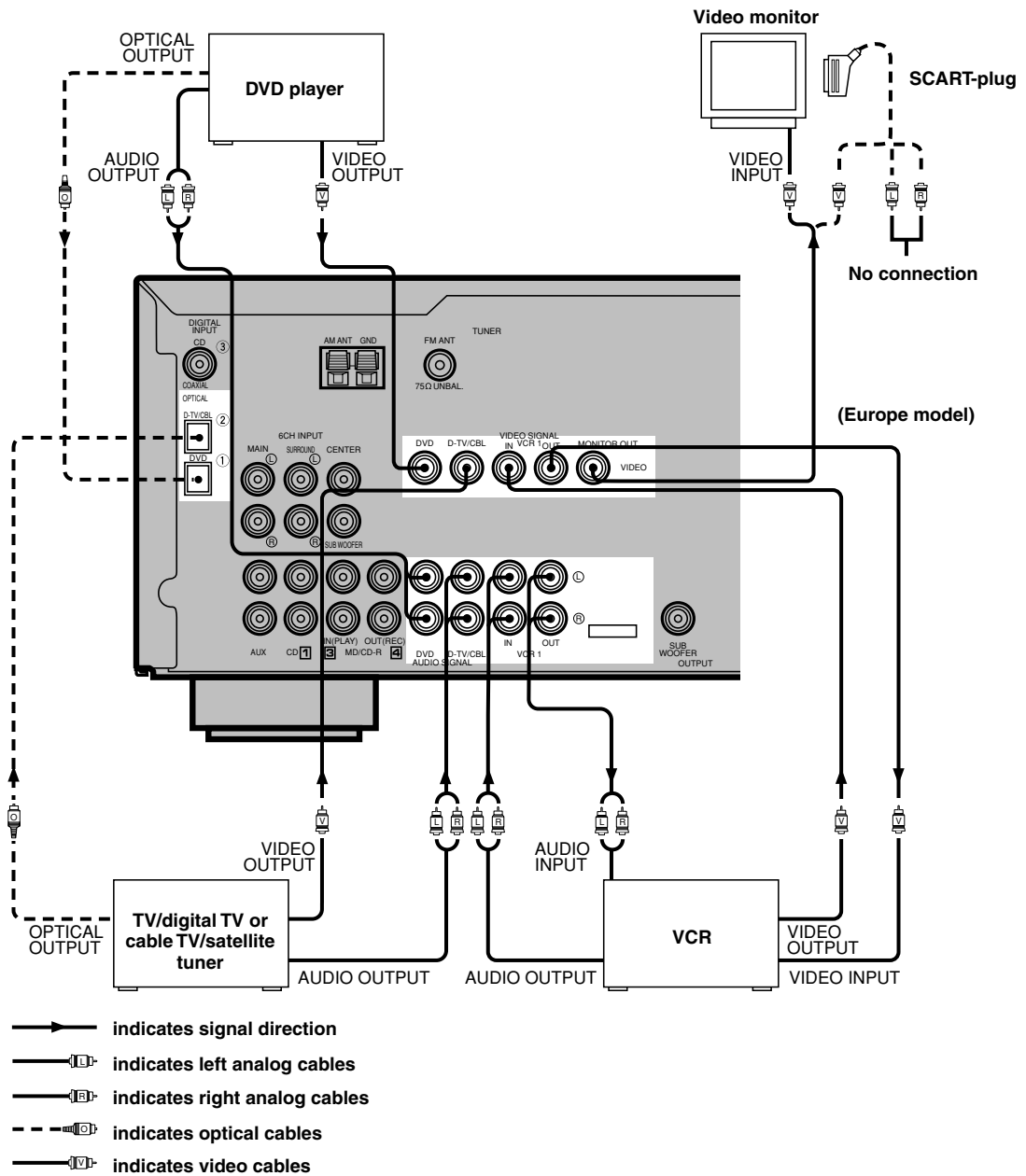

PREPARATION

**When using an LD player**

Connect the LD player output to the DVD jack.

If the LD player has an OPTICAL digital output jack, connect it to this unit's OPTICAL DVD jack. If it has analog jacks, connect it to the analog DVD jacks. If it has an "RF OUTPUT jack" to output a Dolby Digital RF signal (AC-3), use a commercially available RF demodulator and connect it to the OPTICAL DVD jack.

If connecting a DVD player and an LD player, connect the LD player to the digital input jack (ex. D-TV/CBL) or the analog input jack (D-TV/CBL or VCR 1). For details on connections and operations, refer to the operation instructions for the LD player.

Note that this unit's remote control can be used to operate the LD player by setting the corresponding manufacturer code for the DVD/LD mode.

English

## Connecting Speakers

Be sure to connect the right channel (R), left channel (L), “+” (red) and “-” (black) properly. If the connections are faulty, no sound will be heard from the speakers, and if the polarity of the speaker connections is incorrect, the sound will be unnatural and lack bass.

### CAUTION

- Use speakers with the specified impedance shown on the rear panel of this unit.
- Do not let the bare speaker wires touch each other and do not let them touch any metal part of this unit. This could damage the unit and/or speakers.

### ■ Speaker cables

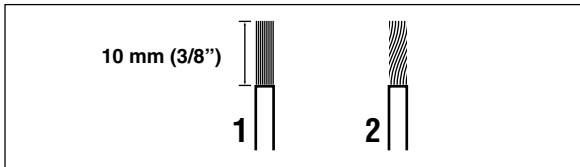

- 1** Remove approx. 10 mm (3/8”) of insulation from each of the speaker cables.
- 2** Twist the exposed wires of the cable together to prevent short circuits.

### ■ Connecting to the MAIN SPEAKERS terminals

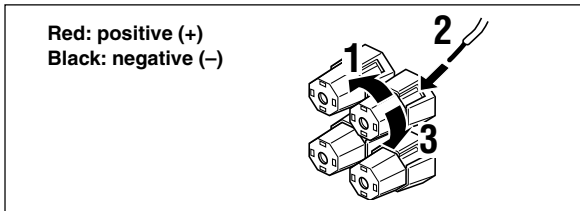

Red: positive (+)  
Black: negative (-)

- 1** Unscrew the knob.
- 2** Insert one bare wire into the hole in the side of each terminal.
- 3** Tighten the knob to secure the wire.

### ■ Connecting to the REAR and CENTER SPEAKERS terminals

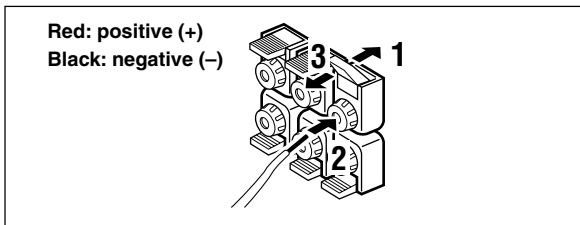

Red: positive (+)  
Black: negative (-)

- 1** Open the tab.
- 2** Insert one bare wire into the hole of each terminal.
- 3** Return the tab to secure the wire.

### ■ Main speaker terminals

One or two speaker systems can be connected to these terminals. If you use only one speaker system, connect it to either of the SPEAKERS A or B terminals.

### ■ Rear speaker terminals

A rear speaker system can be connected to these terminals.

### ■ Center speaker terminals

A center speaker can be connected to these terminals.

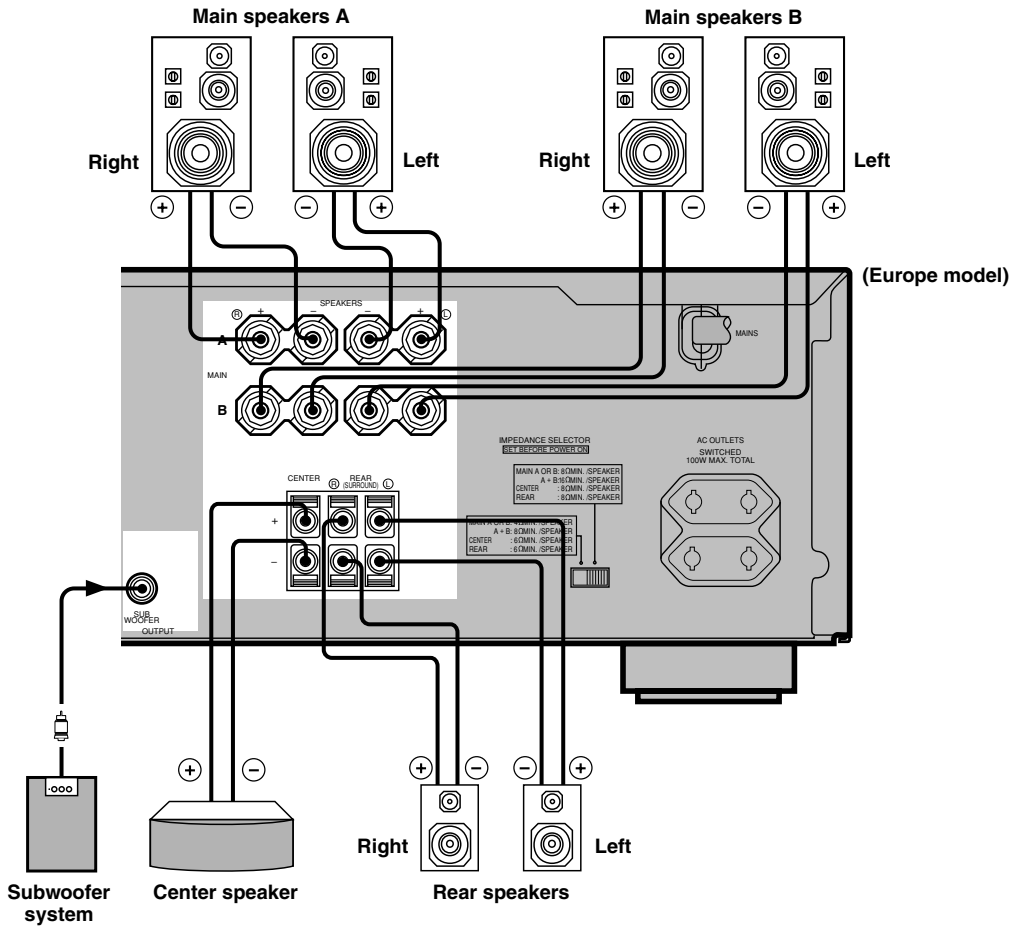

PREPARATION

### ■ Subwoofer connection

When using a subwoofer with built-in amplifier, including the YAMAHA Active Servo Processing Subwoofer System, connect the input jack of the subwoofer system to this jack. Low bass signals distributed from the main, center and/or rear channels are directed to this jack. (The cut-off frequency of this jack is 90 Hz.) The LFE (low-frequency effect) signals generated when Dolby Digital or DTS is decoded are also directed if they are assigned to this jack.

#### Notes

- Adjust the subwoofer volume according to the operation instructions for the subwoofer. (Fine adjustment is possible using this unit's output level control of the effect speakers.)
- Depending on the settings of "1 SPEAKER SET", "LFE LEVEL (5 DOLBY D. SET)" and "6 DTS SET" in the SET MENU, some signals may not be output from the SUBWOOFER jack.

English

## IMPEDANCE SELECTOR Switch

### WARNING

Do not change the IMPEDANCE SELECTOR switch setting while the power to this unit is on, otherwise the unit may be damaged.

If this unit fails to turn on when STANDBY/ON (or POWER) is pressed, the IMPEDANCE SELECTOR switch may not be fully slid either position. If so, slide the switch to either position fully when this unit is in the standby mode.

Select the right or left position according to the impedance of speakers in your system. Be sure to move this switch only when this unit is in the standby mode.

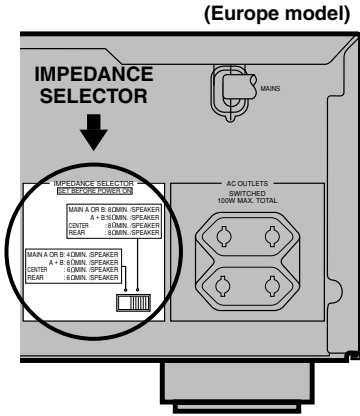

Switch position	Speaker	Impedance level
Left	Main	If you use one set of main speakers, the impedance of each speaker must be 4 Ω or higher.
		If you use two sets of main speakers, the impedance of each speaker must be 8 Ω or higher.
	Center	The impedance must be 6 Ω or higher.
	Rear	The impedance of each speaker must be 6 Ω or higher.
Right	Main	If you use one set of main speakers, the impedance of each speaker must be 8 Ω or higher.
		If you use two sets of main speakers, the impedance of each speaker must be 16 Ω or higher.
	Center	The impedance must be 8 Ω or higher.
	Rear	The impedance of each speaker must be 8 Ω or higher.

## Connecting the Power Supply Cords

After completing all connections, connect the AC power cord to an AC power outlet. Disconnect the AC power cord if you will not use this unit for a long period of time.

### AC OUTLETS (SWITCHED)

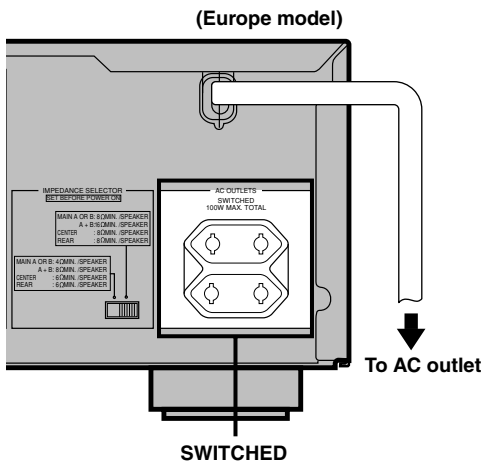

Europe model ..... 2 OUTLETS  
 U.K. model ..... 1 OUTLET  
 Use these outlets to connect the power cords only from your audio/video components to this unit. The power to the AC OUTLET(S) is controlled by this unit's STANDBY/ON (or POWER). These outlets will supply power to any connected component whenever this unit is turned on. The maximum power (total power consumption of components) that can be connected to the AC OUTLET(S) is 100 W.



# ADJUSTING THE SPEAKER BALANCE

This procedure lets you adjust the sound output level balance between the main, center and rear speakers by using the built-in test tone generator. When this adjustment is performed, the sound output level heard at the listening position will be the same from each speaker. This is important for the best performance of the digital sound field processor, the Dolby Pro Logic decoder, Dolby Digital decoder and DTS decoder.

### Note

- Since this unit cannot enter the test mode while headphones are connected to this unit, be sure to unplug the headphones from the PHONES jack when using the test tone.

## Before You Start Adjusting

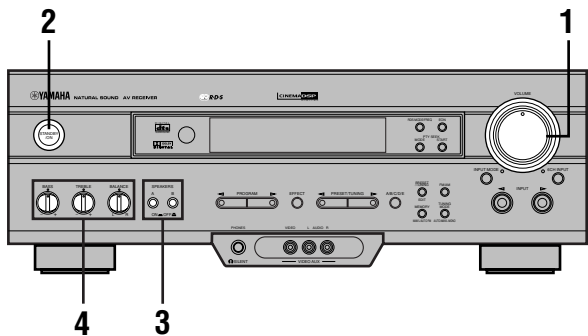

**1** Set the volume at the minimum level.

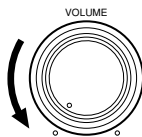

**2** Turn the power on.



**3** Press **SPEAKERS A** or **B** to select the main speakers to be used.

If you use two main speaker systems, press both A and B.

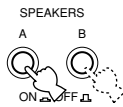

**4** Set **BASS**, **TREBLE** and **BALANCE** to the center position.

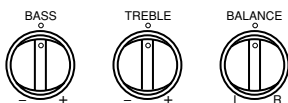

## Using the Test Tone

The adjustment of each speaker sound output level should be performed at your listening position with the remote control.

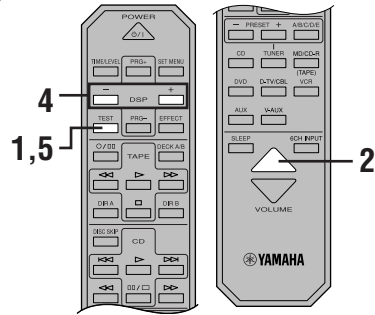

**1** Press **TEST**.

“TEST LEFT” appears on the display.



**2** Turn up the volume.

You will hear a test tone (like pink noise) from each speaker for about two seconds in following order: left main speaker, center speaker, right main speaker, right rear speaker and left rear speaker. The display changes as shown below.

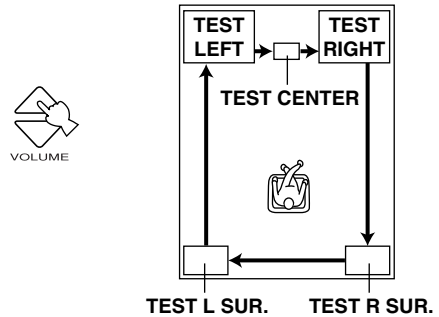

### Notes

- If the test tone cannot be heard, turn down the volume, set the unit in the standby mode and check the speaker connections.
- If the test tone cannot be heard from the center speaker, check the setting of “CENTER SP” in the SET MENU.

- 3** Adjust **BALANCE** on the front panel so that the sound output level of the right main speaker and the left main speaker is the same.

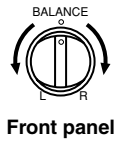

- 4** Press **-/+** repeatedly to adjust the output level of the speaker currently outputting the test tone so that it becomes almost the same as that of the main speakers.

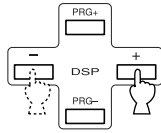

While adjusting, the test tone is heard from the selected speaker.

- 5** When the adjustment is complete, press **TEST**.

Test tone stops.



**Notes**

- If “CENTER SP” in the SET MENU is set to the NON position, the sound output level of the center speaker cannot be adjusted in step 4. The center channel sound is automatically output from the right and left main speakers.
- For details on adjusting the subwoofer speaker, refer to “DELAY TIME AND SPEAKER OUTPUT LEVELS” on page 40.
- After adjusting with the test tone, it is possible to adjust the speaker level to taste while listening to the playback of an actual source. Refer to “DELAY TIME AND SPEAKER OUTPUT LEVELS” on page 40.



- Once you have completed the adjustments, you can only adjust the overall volume level of your audio system by using **VOLUME** (or **VOLUME** (△/▽)).
- If there is insufficient sound output from the center and rear speakers, you may decrease the main speaker output level by setting “MAIN LVL” in the SET MENU to “-10 dB”.



# PLAYING A SOURCE

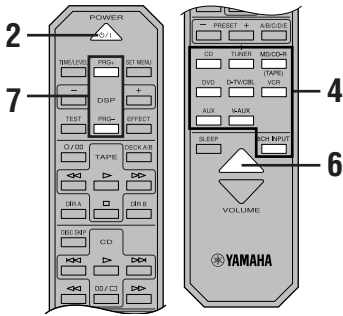
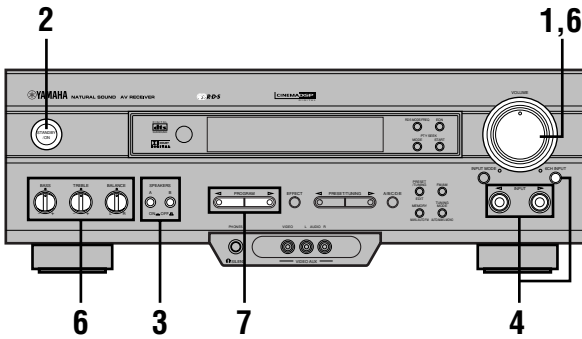

**1** Set the volume at the minimum level.

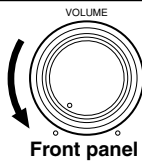

Front panel

**2** Turn the power on.



Front panel

or



Remote control

**3** Press **SPEAKERS A** or **B** to select the main speakers to be used.

If you use two main speaker systems, press both A and B.

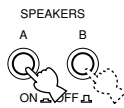

Front panel

**4** Select the desired input source with **INPUT** </> (or the input selector buttons). (Turn on the video monitor for video sources.)

The name of the selected input source appears on the display.

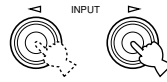

Front panel

or

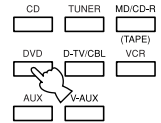

Remote control

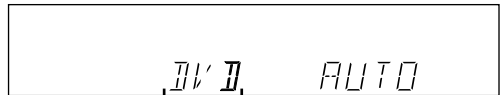

Input source

To select a source connected to the **6CH INPUT** jacks

Press **6CH INPUT** so that “6CH INPUT” appears on the display.



Front panel

or



Remote control



## Notes

- An audio source can not be played if “6CH INPUT” appears. Press 6CH INPUT to turn off “6CH INPUT”.
- If you select and play a video source when “6CH INPUT” appears, the playback result will be a video image from the video source and the sound from the audio source selected by using “6CH INPUT”.



- The current input mode is also shown. Refer to “Input Modes and Indications” on page 23 for details.

**5 Play the source.**

Refer to the instructions for the source component (and “TUNING” for details).

**6 Adjust the volume to the desired output level.**

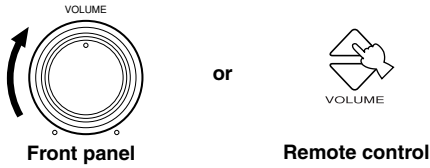

If desired, adjust BASS, TREBLE, BALANCE, etc. These controls are only effective for the sound from the main speakers.

- BASS controls the low-frequency response.
- TREBLE controls the high-frequency response.
- BALANCE adjusts the balance of the output volume from the right and left main speakers.

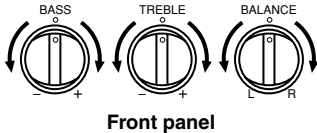

**When you have finished using this unit**

Press **STANDBY/ON** (or **POWER**) to set this unit in the standby mode.

**■ BGV (background video) function**

The BGV function allows you to combine a video image from a video source with a sound from an audio source. (For example, you can listen to classical music while you are watching a video.) This function can only be controlled with the remote control.

Play a video source, and then select an audio source with the input selector buttons on the remote control. The BGV function does not work if you select the audio source with **INPUT** <|/> on the front panel.

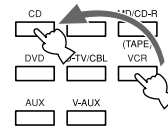

**7 Use the digital sound field processor.**

Refer to “Selecting a DSP Program”.

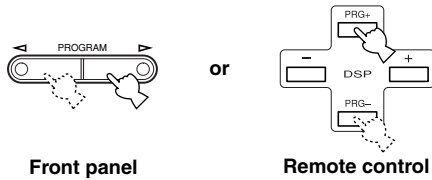



## Input Modes and Indications

This unit comes with various input jacks. If your component is connected to more than one type of input jack, you can set the priority of the input signal.

**Press INPUT MODE (or the input selector button that you have pressed to select the input source on the remote control) repeatedly until the desired input mode is shown on the display.**

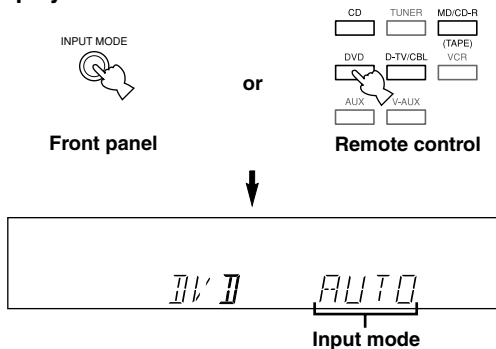

- AUTO:** In this mode, the input signal is automatically selected in the following order:
- 1) Dolby Digital or DTS signal
  - 2) Digital (PCM) signal
  - 3) Analog signal
- DTS:** In this mode, only the digital input signal encoded with DTS is selected even if another signal is input at the same time.
- ANALOG (ANLG):** In this mode, only the analog input signal is selected even if a digital signal is input at the same time.

### Notes

- If digital signals are input from both the COAXIAL and OPTICAL jacks, the digital signal from the COAXIAL jack is selected.
- When AUTO is selected, this unit automatically determines the type of signal. If this unit detects a Dolby Digital or DTS signal, the decoder automatically switches to the appropriate setting and reproduces 5.1 channel source.
- The sound output may be interrupted for some LD players and DVD players in the following situation:  
When the input mode has been set to AUTO and a search is performed while playing the source encoded with a Dolby Digital or DTS signal, the sound may delay for a moment when playback is resumed.
- Depending on the LD player, playback may not be made when playing an LD that is not digitally recorded with the input mode set to AUTO. If this happens, set the input mode to ANALOG.

## Notes on playing a source encoded with a DTS signal

- If the digital output data of the player has been processed in any way, you may not be able to perform DTS decoding even if you make a digital connection between this unit and the player.
- If you play a source encoded with a DTS signal and set the input mode to ANALOG, this unit reproduces the noise of an unprocessed DTS signal. When you want to play a DTS source, be sure to connect the source to a digital input jack and set the input mode to AUTO or DTS.
- If you switch the input mode to ANALOG while playing a source encoded with a DTS signal, this unit reproduces no sound.
- The following phenomena may occur if the input mode is set to AUTO when playing back a source encoded with DTS:
  - If you continue to play a source encoded with a DTS signal, this unit automatically switches to the “DTS-decoding” mode to prevent noise from being generated during subsequent operation. (The “**dts**” indicator lights up on the display.) The “**dts**” indicator may flash immediately after playback of a source encoded with a DTS signal has finished. Only a source encoded with a DTS signal can be played back while this indicator is flashing. (The indicator will flash for less than a minute.) If you want to play a normal PCM source soon, set the input mode back to AUTO.
  - The “**dts**” indicator may flash when a search or skip operation is performed. If this status continues for a certain length of time, the unit will automatically switch from the “DTS-decoding” mode to PCM digital signal input mode and the “**dts**” indicator will go out.

## Selecting a DSP Program

You can enhance your listening experience by selecting a DSP program. Refer to “SOUND FIELD PROGRAM” for details about each program.



- Make sure that the sound effect is turned on (see page 25).

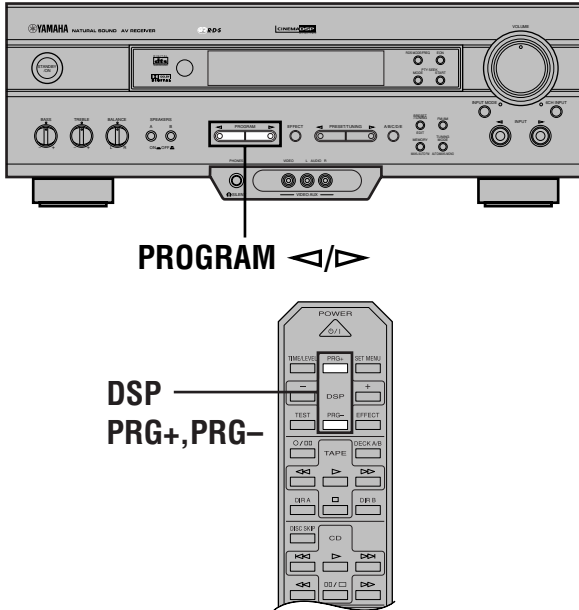

Press **PROGRAM** ◀ or ▶ (or **DSP PRG+** or **PRG-**) repeatedly to select the desired program.

The name of the selected program appears for a moment and the selected DSP program indicator lights up on the display.

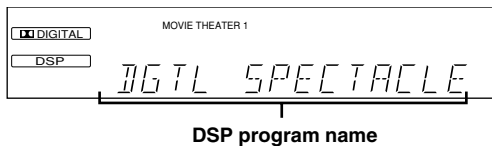
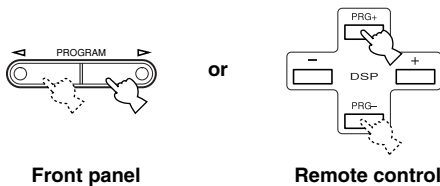

- If desired, adjust the delay time and the sound output level of each speaker. (Refer to “DELAY TIME AND SPEAKER OUTPUT LEVELS” on page 40 for details.)

## Notes

- Choose a DSP program based on your listening preference, and not on the name of the program. The acoustics of your listening room affect the DSP program. Minimize the sound reflections in your room to maximize the effect created by the program.
- When you select an input source, this unit automatically selects the last DSP program used with that source.
- When you set this unit in the standby mode, the current source and DSP program are memorized and are automatically selected when you turn on the power again.
- If a Dolby Digital or DTS signal is input when the input mode is set to AUTO, the DSP program automatically switches to the appropriate decoding program.
- When a monaural source is being played with PRO LOGIC/NORMAL or PRO LOGIC/ENHANCED, no sound will be heard from the main speakers and the rear speakers. Sound can only be heard from the center speaker. However, if “CENTER SP” in the SET MENU is set to NON, the center channel sound is output from the main speakers.
- When a source connected to the 6CH INPUT jacks of this unit is selected, the digital sound field processor cannot be used.

## ■ Virtual CINEMA DSP and SILENT CINEMA

### Virtual CINEMA DSP

Virtual CINEMA DSP allows you to enjoy the sound field effects of the DSP program without rear speakers. Using YAMAHA original technology, natural surround reproduction is possible through the generation of a virtual speaker.

The sound field processing is changed to the Virtual CINEMA DSP mode by setting "REAR LR SP" on the SET MENU to NON. Virtual CINEMA DSP is performed by using the main speakers.

#### Note

- This unit is not set in the Virtual CINEMA DSP mode even if "REAR LR SP" is set to NON in the following cases:
  - when the 5CH STEREO, PRO LOGIC/NORMAL, DOLBY DIGITAL/NORMAL or DTS/NORMAL program is selected;
  - when the sound effect is turned off;
  - when 6CH INPUT is selected as the input source;
  - when the Dolby Digital KARAOKE source is played;
  - when using the test tone; or
  - when connecting the headphones (you will hear SILENT CINEMA).

### SILENT CINEMA

SILENT CINEMA allows you to enjoy the realistic feel of the DSP program while using headphones. This feature delivers powerful surround reproduction just as if listening through the speakers.

You can listen to SILENT CINEMA by connecting your headphones to the PHONES jack while the effect speakers are on.

## Canceling the Sound Effect (turning off the effect speakers)

**Press EFFECT to cancel the sound effect and monitor only the main sound.**

Press EFFECT again to turn the sound effect back on.

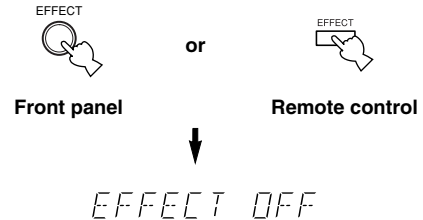

#### Notes

- If the sound effect is canceled when Dolby Digital or DTS is decoding, the sounds of the center and rear channels are mixed and output from the main speakers.
- If you turn off the sound effect when Dolby Digital or DTS is decoding, it may happen that the sound is output faintly or not output normally, depending on the source. In that case, turn back on the sound effect.

## Connecting the Antennas

Both AM and FM indoor antennas are included with this unit. In general, these antennas should provide sufficient signal strength.

Connect each antenna correctly to the designated terminals.

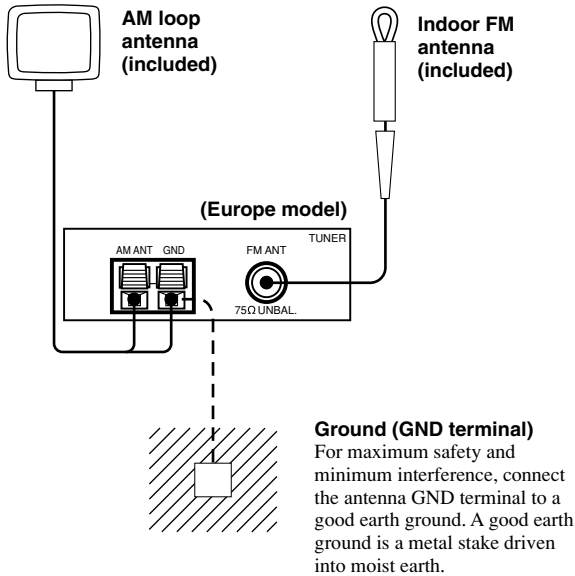

### Connecting the indoor FM antenna

Connect the included indoor FM antenna to the FM ANT 75Ω UNBAL. terminal.

#### Note

- Do not connect an outdoor FM antenna and the indoor FM antenna at the same time.

### Connecting the AM loop antenna

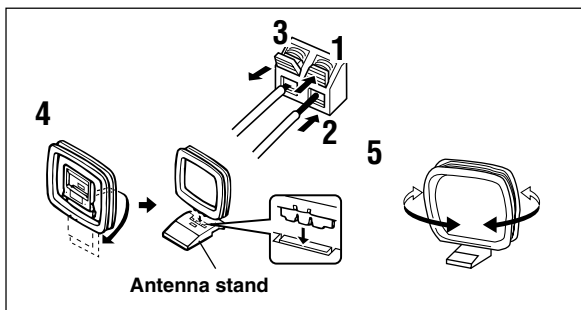

**1** Press and hold the tab to unlock the terminal hole.

**2** Insert the AM loop antenna lead wires into the AM ANT and GND terminals.

**3** Release the tab to lock the lead wires.

Lightly pull the lead wires to confirm a good connection.

**4** Attach the loop antenna to the antenna stand.

**5** Orient the AM loop antenna so that the best reception is obtained.



- The AM loop antenna can be removed from the stand and attached to a wall, etc.

#### Notes

- The AM loop antenna should be placed away from this unit.
- The AM loop antenna should always be connected, even if an outdoor AM antenna is connected to this unit.

A properly installed outdoor antenna provides clearer reception than an indoor one. If you experience poor reception quality, an outdoor antenna may improve the quality. Consult the nearest authorized YAMAHA dealer or service center about the outdoor antennas.

### Connecting a coaxial cable to the included 75-ohm/300-ohm antenna adapter (U.K. model only)

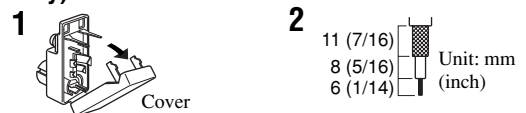

Open the cover of the included 75-ohm/300-ohm antenna adapter.

Cut the external sleeve of the 75-ohm coaxial cable and prepare it for connection.

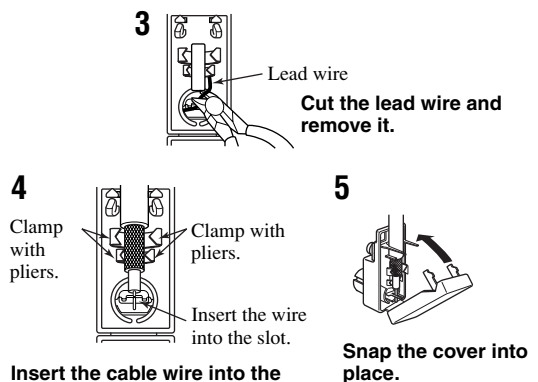

## Automatic Tuning

Automatic tuning is effective when station signals are strong and there is no interference.

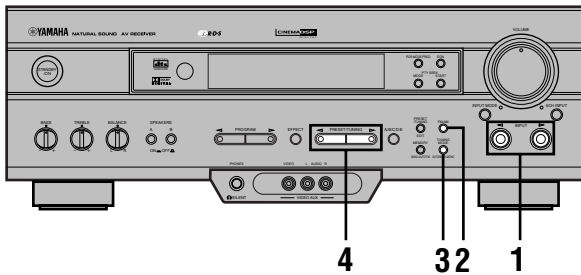

- 1** Use INPUT  $\triangleleft$ / $\triangleright$  to select TUNER as the input source.

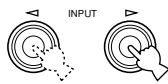

- 2** Press FM/AM to select the reception band (FM or AM).

“FM” or “AM” appears on the display.

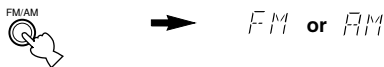

- 3** Press TUNING MODE (AUTO/MAN'L MONO) so that the “AUTO” indicator lights up on the display.



If “>” appears on the display next to the band indication, press PRESET/TUNING (EDIT) to turn it off.

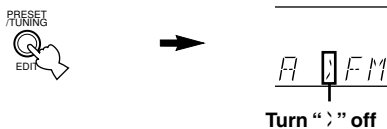

- 4** Press PRESET/TUNING  $\triangleleft$  once to tune in to a lower frequency and  $\triangleright$  once to tune in to a higher frequency.

Press the button again if the tuning search does not stop at the desired station.

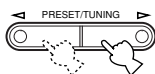

- Use the manual tuning method if the tuning search does not stop at the desired station (because the signal from the station is weak).
- When tuned in to a station, the “TUNED” indicator lights up and the frequency of the received station is shown on the display. If an RDS station that offers the PS data service is being received, the station name is shown instead of the frequency on the display.

## Manual Tuning

If the signal from the station you want to select is weak, you must tune in to it manually.

- 1** Use INPUT  $\triangleleft$ / $\triangleright$  to select TUNER as input source.

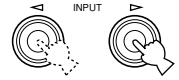

- 2** Press FM/AM to select the reception band (FM or AM).

“FM” or “AM” appears on the display.



- 3** Press TUNING MODE (AUTO/MAN'L MONO) so that the “AUTO” indicator goes off.



If “>” appears on the display next to the band indication, press PRESET/TUNING (EDIT) to turn it off.

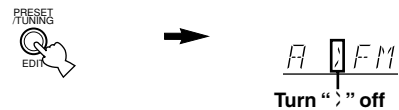

- 4** Press PRESET/TUNING  $\triangleleft$  or  $\triangleright$  to tune in to the desired station.

To continue the tuning search, hold down the button.

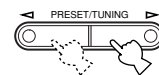

### Note

- If you tune in manually to an FM station, it will be automatically received in monaural mode to increase the signal quality.

## Automatic Preset Tuning (for RDS stations only)

You can make use of the automatic preset tuning function for RDS stations only. This function enables the unit to automatically tune in with strong signals and to sequentially store up to 40 RDS stations (5 groups x 8 stations).

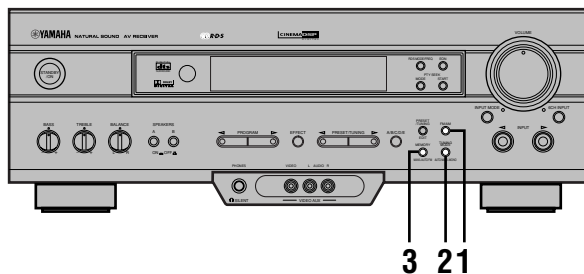

### 1 Press FM/AM to select the FM band.



### 2 Press TUNING MODE (AUTO/MAN'L MONO) so that the "AUTO" indicator lights up on the display.



### 3 Hold down MEMORY (MAN'L/AUTO FM) for about 3 seconds.

The preset number, the "MEMORY" and "AUTO" indicators flash. After about 5 seconds, automatic preset tuning begins from the frequency currently displayed toward the higher frequencies.

Received stations are sequentially stored as A1, A2 ... A8. If more than 8 stations have been tuned, they are stored as preset station numbers in other groups (B, C, D and E) in that order.

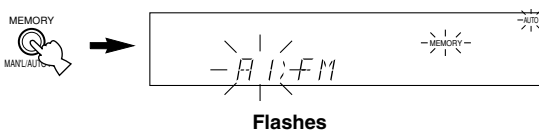

## Automatic preset tuning options

You can select the preset number from which the unit will store RDS stations and/or begin tuning toward lower frequencies. Before automatic preset tuning begins (after pressing MEMORY in step 3),

1. Press A/B/C/D/E and PRESET/TUNING < or > to select the preset number with which the first station will be stored. The automatic preset tuning will stop when stations have all been stored up to E8.
2. Press PRESET/TUNING (EDIT) to turn ">" off and then press PRESET/TUNING < to begin tuning toward lower frequencies.

## When automatic preset tuning is completed

The display shows the frequency of the last preset station. Check the contents and the number of preset stations by following the procedure in the section "To Recall a Preset Station" on page 29.

### Notes

- A new setting can be stored in place of the former one.
- The reception mode is stored along with the station frequency.
- You can manually replace a preset station with another FM or AM station by simply using the manual preset tuning method.
- Automatic preset tuning will be performed for all RDS network stations until all have been stored up to E8. Even if the number of received stations is not enough to be stored up to E8, automatic preset tuning is automatically ended after searching for all stations.
- Only RDS stations with sufficient signal strength are stored by automatic preset tuning. If the station you want to store is weak in signal strength, tune in to it manually in monaural mode and store it by using the manual preset tuning method. (There may be a case that this unit cannot receive a station which could be received by using the automatic tuning method. This is because this unit receives a large amount of PI (Program Identification) data along with the station.)

### Memory back-up

The memory back-up circuit prevents the stored data from being lost when this unit is set in the standby mode. If, however, the power cord is disconnected from the AC power outlet or the power is cut for more than one week, the memory will be erased. If so, store the stations again by using preset tuning methods.

## Manual Preset Tuning

You can also store up to 40 stations (5 groups x 8 stations) manually.

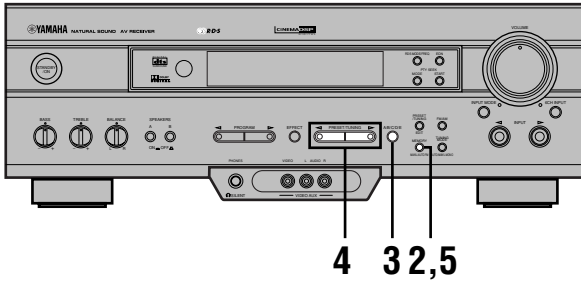

- 1 Tune in to the desired station.**  
Refer to “Automatic/Manual Tuning” for the tuning procedure.
- 2 Press MEMORY (MAN'L/AUTO FM).**  
The “MEMORY” indicator flashes for about 5 seconds.

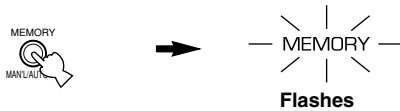

- 3 Press A/B/C/D/E repeatedly to select the desired group (A to E) of preset stations before the “MEMORY” indicator goes off.**  
Make sure that “>” appears on the display. The selected group appears on the display.



- 4 Press PRESET/TUNING < or > to select a preset station number (1 to 8) with which you want to store the station before the “MEMORY” indicator goes off.**

Press < to select a lower preset station number and > to select a higher preset station number.

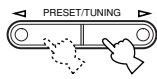

- 5 Press MEMORY (MAN'L/AUTO FM) before the “MEMORY” indicator goes off.**  
The displayed station has been stored as the preset group and number you have selected, and the reception band and frequency appear and the “TUNED” indicator lights up on the display.

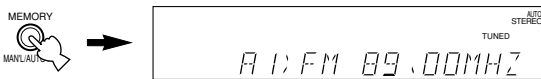

- 6 Repeat steps 1 to 5 to store other stations.**

### Notes

- A new setting can be stored in place of the former one.
- The reception mode is stored along with the station frequency.

## To Recall a Preset Station

You can recall any desired station simply by selecting the preset station number with which it was stored.

You can also recall a preset station with the remote control.

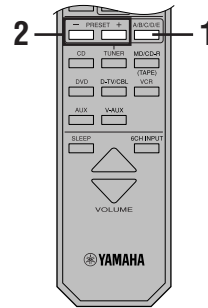
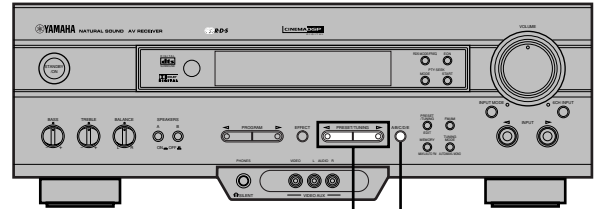

- 1 Press A/B/C/D/E to select the required group of preset stations.**  
Make sure that “>” appears on the display.

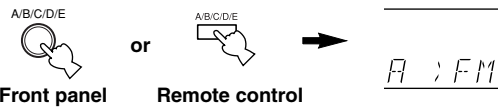

- 2 Press PRESET/TUNING < or > (or PRESET +/-) to select a preset station number (1 to 8).**  
The preset group and number appear on the display along with the reception band, frequency, and the “TUNED” indicator lights up.

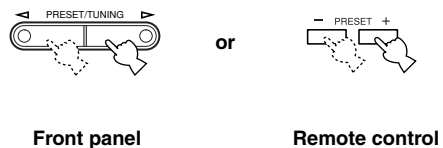

Front panel                      Remote control

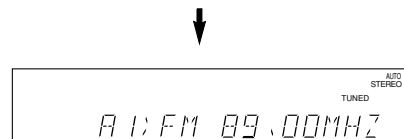

## Exchanging Preset Stations

You can exchange the assignment of two preset stations with each other.

**Example: Exchange preset station “E1” with “A5”**

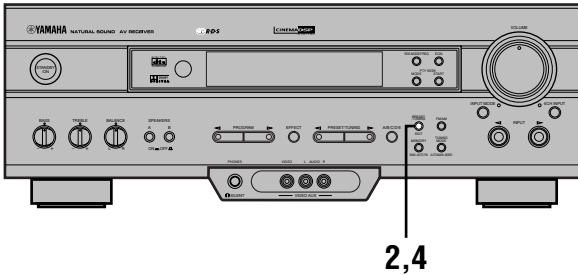

**1 Recall preset station “E1”.**

Refer to the procedure in the section “To Recall a Preset Station” on page 29.

**2 Hold down (PRESET/TUNING) EDIT for about 3 second.**

“E1” and the “MEMORY” indicator flash.

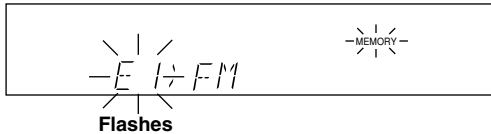

**3 Recall preset station “A5” by using the buttons on the front panel.**

“A5” and the “MEMORY” indicator flash.

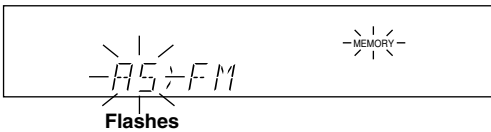

**4 Press (PRESET/TUNING) EDIT again.**

The display shows the exchange of stations has been completed.

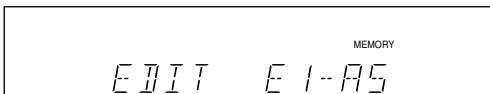





# RECEIVING RDS STATIONS

Radio Data System (RDS) is a data transmission system by FM stations in many countries. Stations using this system transmit an inaudible stream of data in addition to the normal radio signal.

RDS data contains various information such as PI (Program Identification), PS (Program Service name), PTY (Program Type), RT (Radio Text), CT (Clock Time), EON (Enhanced Other Networks), etc. The RDS function is carried out among the network stations.

## Description of RDS Data

This unit can receive PI, PS, PTY, RT, CT, and EON data when receiving RDS broadcasting stations.

### ■ PS (Program Service name) mode:

The name of the RDS station being received is displayed.

### ■ PTY (Program Type) mode:

The program type on the RDS station being received is displayed. There are 15 program types to classify RDS stations. You can make this unit search for a station which is broadcasting a program of the desired type. Refer to "PTY SEEK Function" for details.

### ■ RT (Radio Text) mode:

Information about the program (such as the title of the song, name of the singer, etc.) on the RDS station being received is displayed by a maximum of 64 alphanumeric characters, including the umlaut symbol. If other characters are used for RT data, they are displayed with under-bars.

### ■ CT (Clock Time) mode:

The current time is displayed and updated every minute. If the data are accidentally cut off, "CT WAIT" may appear.

### ■ EON (Enhanced Other Networks):

Refer to "EON Function" on page 33.

## Changing the RDS Mode

The four modes are available in this unit for displaying RDS data. When an RDS station is being received, PS, PTY, RT and/or CT that correspond to the RDS data services offered by the station light up on the display. Press RDS MODE/FREQ repeatedly to change the display mode among the RDS data offered by the transmitting station in the order shown below. Illumination of the red indicator next to the RDS mode indicator shows that the corresponding RDS mode is now selected.

### Notes

- When an RDS station is being received, do not press RDS MODE/FREQ until one or more RDS mode indicators light up on the display. If you press the button before the indicators light up on the display, the mode cannot be changed. This is because the unit has not yet received all of the RDS data on the station.
- RDS data not offered by the station cannot be selected.
- The RDS data service cannot be utilized by this unit if the received signal is not strong enough. In particular, the RT mode requires a large amount of data to be received, so it is possible that the RT mode may not be displayed even if other RDS modes (PS, PTY, etc.) are displayed.
- RDS data cannot sometimes be received under poor reception conditions. If so, press TUNING MODE so that the "AUTO" indicator goes off from the display. Although the reception mode is changed to monaural by this operation, when you change the display to RDS mode, RDS data may be displayed.
- If the signal strength is weakened by external interference during the reception of an RDS station, the RDS data service may be cut off suddenly and "...WAIT" will appear on the display.

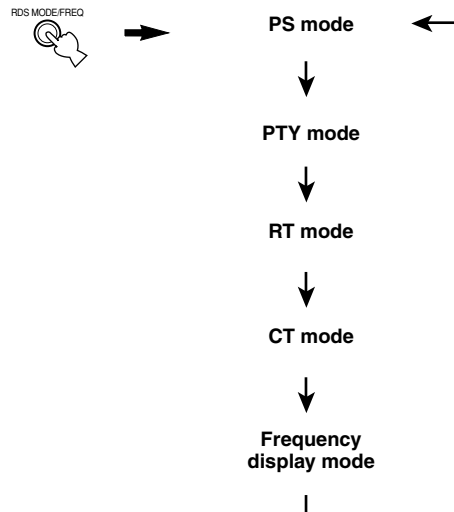

## PTY SEEK Function

If you select the desired program type, the unit automatically searches all preset RDS stations that are broadcasting a program of the required type.

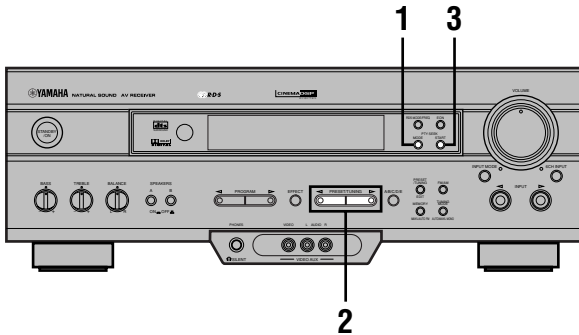

### 1 Press PTY SEEK MODE to set the unit in the PTY SEEK mode.

The program type of the station being received or “NEWS” flashes on the display.

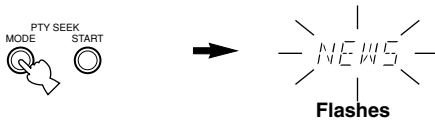

### 2 Press PRESET/TUNING ◀ or ▶ to select the desired program type.

The selected program type flashes on the display.

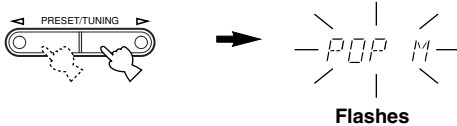

### 3 Press PTY SEEK START to begin searching all preset RDS stations.

The selected program type flashes and the “PTY HOLD” indicator lights up on the display while searching for stations.

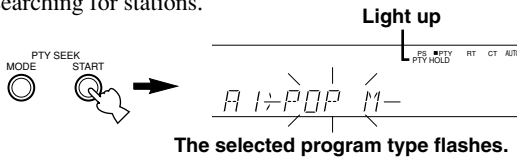

The selected program type flashes.

- If a station that is broadcasting a program of the required type is found, the unit stops at that station.
- If the called station is not the desired one, press PTY SEEK START again. The unit begins searching for another station that is broadcasting a program of the same type.

### ■ To cancel this function

Press PTY SEEK MODE twice.

### ■ Program types in the PTY mode

There are 15 program types to classify RDS stations.

NEWS	News
AFFAIRS	Current affairs
INFO	General information
SPORT	Sports
EDUCATE	Education
DRAMA	Drama
CULTURE	Culture
SCIENCE	Science
VARIED	Light entertainment
POP M	Pops
ROCK M	Rock
M.O.R. M	Middle-of-the-road music (easy-listening)
LIGHT M	Light classics
CLASSICS	Serious classics
OTHER M	Other music

## EON Function

This function uses the EON data service on the RDS station network. If you simply select the desired program type (NEWS, INFO, AFFAIRS or SPORT), the unit automatically searches for all preset RDS stations that are scheduled to broadcast a program of the required type and switches from the station being currently received to the new station when the broadcasts starts.

### Note

- This function can only be used when an RDS station that offers the EON data service is being received. When such a station is being received, the “EON” indicator lights up on the display.

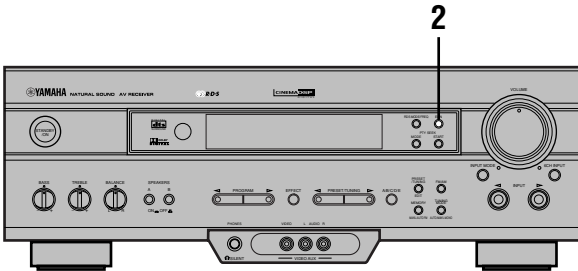

### 1 Make sure that the “EON” indicator lights up on the display.

If the “EON” indicator does not light up, tune in to another RDS station so that the “EON” indicator lights up.

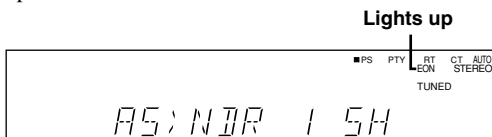

### 2 Press EON repeatedly to select the desired program type (NEWS, INFO, AFFAIRS or SPORT).

The selected program type name indicator lights up on the display.

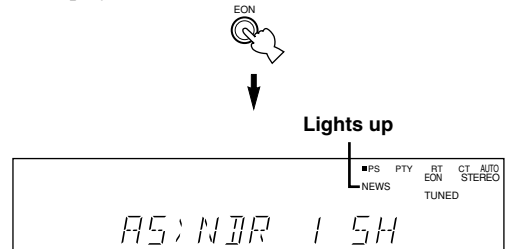

- If a preset RDS station of the selected program type starts broadcasting, the unit will automatically switch from the program being currently received to that program. The program type name indicator flashes.

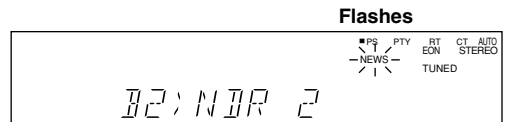

- When broadcasting of the required program ends, the previously received station (or another program on the same station) is recalled.



### ■ To cancel this function

Press EON repeatedly until no program type name lights up on the display.



# RECORDING A SOURCE

Recording adjustments and other operations are performed from the recording component. Refer to the instructions for these components.

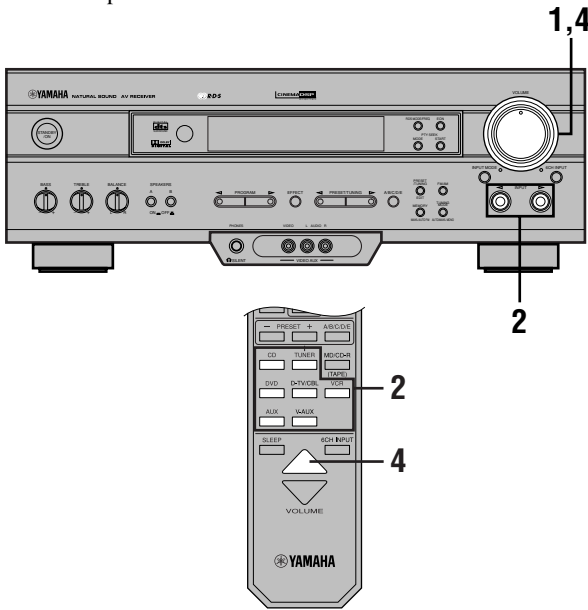

## Notes

- Do a test recording before you start an actual recording.
- When this unit is set in the standby mode, you cannot record between other components connected to this unit.
- The DSP program and the setting of VOLUME, BASS, TREBLE and BALANCE have no effect on the material being recorded.
- A source connected to the 6CH INPUT jacks of this unit cannot be recorded.
- A given input source is not output on the same REC OUT channel. (For example, the signal input from VCR 1 IN is not output on VCR 1 OUT.)
- Check the copyright laws in your country to record from records, CDs, radio, etc. Recording of copyrighted material may infringe copyright laws.

If you play back a video source that uses scrambled or encoded signals to prevent it from being dubbed, the picture itself may be disturbed due to those signals.

- 1** Set the volume at the minimum level.

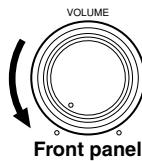

Front panel

- 2** Select the source you want to record.

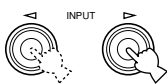

Front panel

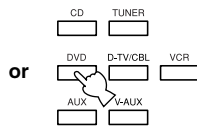

Remote control

- 3** Begin recording by the recording component connected to this unit.

- 4** Play the source and then turn up the volume to confirm the input source.

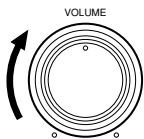

Front panel



Remote control



# SET MENU

The SET MENU consists of 9 items including the speaker mode setting. Use the SET MENU to enjoy the optimum audio/video playback for your system.



- You can adjust the items on the SET MENU while playing a source.

## 1 SPEAKER SET

- CENTER SP
- MAIN SP
- REAR LR SP
- BASS OUT
- MAIN LVL

## 2 HP TONE CTRL

## 3 I/O ASSIGN

## 4 INPUT MODE

## 5 DOLBY D. SET

- LFE LEVEL
- D-RANGE

## 6 DTS SET

## 7 SP DLY TIME

## 8 DISPLAY SET

## 9 MEM. GUARD

### Adjusting the Items on the SET MENU

Adjustment should be made with the remote control.

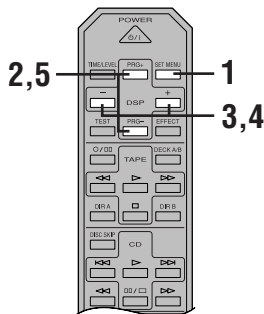

#### Note

- Some items require extra steps to change to the desired setting.

### 1 Press SET MENU to enter the SET MENU.



1 SPEAKER SET

### 2 Press PRG- (or PRG+) repeatedly to select the item (1 to 9) you want to adjust.

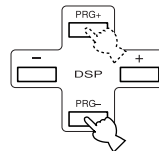

3 I/O ASSIGN



- By pressing SET MENU repeatedly, you can select items in the same order as when pressing PRG-.

### 3 Press - or + once to enter the setup mode of the selected item.

The last setting you adjusted appears on the display.

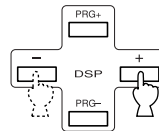

3A(1) CD

Depending on the item, press PRG- (or PRG+) to select a sub item.

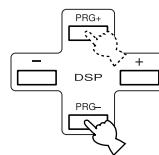

3B(2) DLY

- 4** Press – or + repeatedly to change the setting of the item.

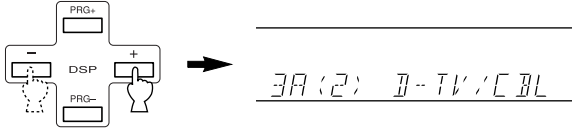

- 5** Press PRG– (or PRG+) repeatedly until the input source name appears to exit from the SET MENU.

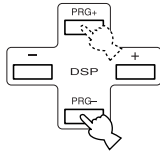

**Memory back-up**

The memory back-up circuit prevents the stored data from being lost even if this unit is set in the standby mode, the power cord is disconnected from the AC outlet, or the power supply is temporarily cut due to power failure. However, if the power is cut for more than one week, the settings of the SET MENU you adjusted will return to the factory settings. If so, adjust the items again.

**1 SPEAKER SET (speaker mode settings)**

Use this feature to select suitable output modes for your speaker configuration.

**Note**

- When 6CH INPUT is selected as the input source, level adjustments in items of “1 SPEAKER SET” are not affected (except “MAIN LVL”).

**■ CENTER SP (center speaker mode)**

By adding a center speaker to your speaker configuration, the unit can provide good dialog localization for many listeners and superior synchronization of sound and images.

Choices: LRG (large), SML (small), NON (none)  
Initial setting: LRG

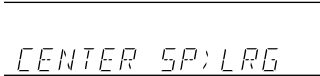

**LRG**

Select this if you have a large center speaker. The entire range of the center channel signal is directed to the center speaker.

**SML**

Select this if you have a small center speaker. The low-frequency signals (90 Hz and below) of the center channel are directed to the speakers selected with “BASS OUT”.

**NON**

Select this if you do not have a center speaker. All of the center channel signals are directed to the left and right main speakers.

**■ MAIN SP (main speaker mode)**

Choices: LARGE, SMALL  
Initial setting: LARGE

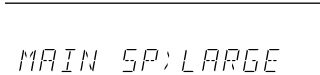

**LARGE**

Select this if you have large main speakers. The entire range of the left and right main channel signal is directed to the left and right main speakers.

**SMALL**

Select this if you have small main speakers. The low-frequency signals (90 Hz and below) of the main channel are directed to the speakers selected with “BASS OUT”.

**Note**

- When you select MAIN for “BASS OUT”, the low-frequency signals (90 Hz and below) of the main channel are directed to the main speakers even if you select SMALL for the main speaker mode.

## ■ REAR LR SP (rear speaker mode)

Choices: LRG (large), SML (small), NON (none)

Initial setting: LRG

REAR LR SP:LRG

### LRG

Select this if you have large left and right rear speakers or if a rear subwoofer is connected to the rear speakers. The entire range of the rear channel signal is directed to the left and right rear speakers.

### SML

Select this if you have small left and right rear speakers. The low-frequency signals (90 Hz and below) of the rear channel are directed to the speakers selected with "BASS OUT".

### NON

Select this if you do not have rear speakers.



- This unit is set in the Virtual CINEMA DSP mode by selecting NON for "REAR LR SP".

## ■ BASS OUT (bass out mode)

LFE signals carry low-frequency effects when this unit decodes a Dolby Digital or DTS signal. Low-frequency signals are defined as 90 Hz and below.

Choices: SWFR (subwoofer), MAIN, BOTH

Initial setting: BOTH

BASS OUT: BOTH

### SWFR

Select this if you use a subwoofer. The LFE signals are directed to the subwoofer.

### MAIN

Select this if you do not use a subwoofer. The LFE signals are directed to the main speakers.

### BOTH

Select this if you use a subwoofer and you want to mix the main channel low-frequency signals with the LFE signals.

#### Notes

- When playing a 2-channel source (CD, MD, tape, video cassette etc.), select BOTH position to direct low bass signals (below 90 Hz) to the SUBWOOFER jack.
- When you select SMALL (SML) for items "CENTER SP", "MAIN SP" and "REAR LR SP", the low-frequency signals (90 Hz and below) from those channels are added to the LFE and output to the subwoofer.

## ■ MAIN LVL (main level mode)

Change this setting if you cannot match the output level of the center and rear speakers with the main speakers because of the unusually high-efficiency performance of the main speakers.

Choices: NORM (normal), -10 dB

Initial setting: NORM

MAIN LVL: NORM

### NORM (normal)

Normally select this setting.

### -10 dB

Select this if you cannot match the output level of your effect speakers with that of your main speakers when using the test tone. This setting decreases the main speaker output level to about one-third of the normal level.

## 2 HP TONE CTRL (headphone tone control)

Use this feature to adjust the level of the bass and treble when you use your headphones.

Control range (dB): -6 to +3

Initial setting: 0 dB for both BASS and TRBL (treble)

HP BASS 0<sup>dB</sup>

HP TREBLE 0<sup>dB</sup>

### 3 I/O ASSIGN

It is possible to assign jacks according to the component to be used if this unit's DIGITAL INPUT jack settings (component names for jacks) differ from that component. This makes it possible to change the jack assignment and effectively connect more component.

Once you assign, you can select that component with INPUT ◀/▶ (or the input selector buttons).

#### ■ 3A (1) and (2) (for the OPTICAL INPUT jacks)

Initial settings: (1) DVD  
(2) D-TV/CBL

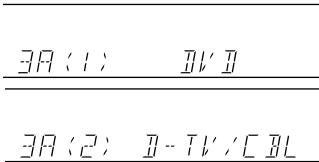

#### ■ 3B (3) (for the COAXIAL INPUT jack)

Initial setting: (3) CD



**Note**

- You cannot select an item more than once for the same type of jack.

### 4 INPUT MODE (initial input mode)

Use this feature to designate the input mode when turning on the power of this unit with the source component connected to more than one type of input jacks.

Choices: AUTO, LAST

Initial setting: AUTO

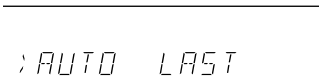

**AUTO**

Select this to allow this unit to automatically detect the type of input signal and select the appropriate input mode.

**LAST**

Select this to set this unit to automatically select the last input mode used for that source.

### 5 DOLBY D. SET (Dolby Digital set)

This setting is effective only when this unit decodes Dolby Digital signals.

#### ■ LFE LEVEL

Use this feature to adjust the output level of the LFE (low-frequency effect) channel when playing back a Dolby Digital signal. The LFE signal carries the low-frequency special effect sound which is only added to certain scenes.

Control value (dB): -20 to 0

Initial setting: 0 dB



**Notes**

- Adjust the LFE level according to the capacity of your subwoofer.
- Normally, around -6 dB to -8 dB is most suitable for listening at home.

#### ■ D-RANGE (dynamic range)

Use this feature to adjust the dynamic range (the difference between the maximum level and the minimum level of sounds).

Choices: MAX, STD (standard), MIN

Initial setting: MAX



- Select MAX for feature films.
- Select STD for general use.
- Select MIN for listening to sources at an extremely low volume level.

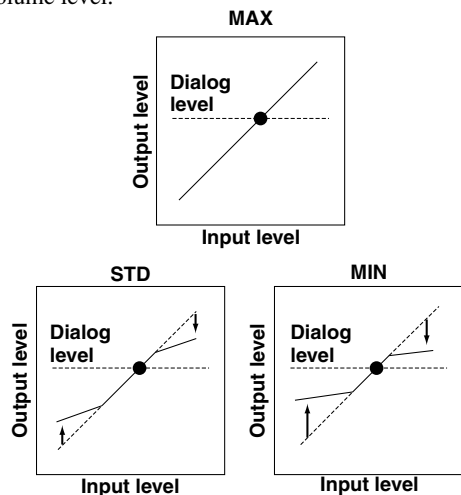

**Note**

- When you select MIN, the sound output may be faint because some Dolby Digital signals are not compatible with the minimum-level dynamic range. In this case, select MAX or STD.



## 6 DTS SET (DTS LFE level)

This setting is effective only when this unit decodes DTS signals.

Use this feature to adjust the output level of the LFE (low-frequency effect) channel when playing back a DTS signal. The LFE signal carries the low-frequency special effect sound which is only added to certain scenes.

Control range (dB): -10 to +10

Initial setting: 0 dB

LFE LEVEL 0<sup>dB</sup>

### Note

- Adjust the LFE level according to the capacity of your subwoofer.

## 7 SP DLY TIME (center delay)

Use this feature to adjust the delay of the center channel sound. This feature works when this unit decodes a Dolby Digital or DTS signal. Ideally, the center speaker should be the same distance from the listening position as the left and right main speakers. However, in most home situations, the center speaker is placed in line with the main speakers. By delaying the sound from the center speaker, the apparent distance from the center speaker to the listening position can be adjusted to make it seem the same as the distance between the left and right main speakers to the listening position. Adjusting the delay time for the center speaker is especially important for giving depth to the dialog.

Control range (ms): 0 to 5

Initial setting: 0 ms

CENTER DELAY 0<sup>ms</sup>

Center speaker image

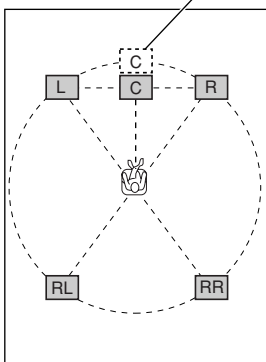

- Increasing the delay by 1 ms simulates moving the speaker about 30 cm (one foot) farther away from the actual position of the center speaker.

## 8 DISPLAY SET

### ■ DIMMER

You can adjust the brightness of the display.

Control range : -4 to 0

Initial setting: 0

DIMMER: 0

## 9 MEM. GUARD (memory guard)

Use this feature to prevent accidental changes to the setting of the SET MENU and other settings on this unit.

Choices: ON, OFF

Initial setting: OFF

MEM.GUARD: OFF

Select ON to protect the following features:

- All SET MENU items
- Center, rear speakers and subwoofer levels
- Delay time adjusted by using TIME/LEVEL

### Notes

- When "9 MEM. GUARD" is set to ON, you cannot use the test tone.
- When "9 MEM. GUARD" is set to ON, you cannot select any other SET MENU items.



# DELAY TIME AND SPEAKER OUTPUT LEVELS

When using the digital sound field processor with the Dolby Pro Logic decoder, Dolby Digital decoder or DTS decoder, you can adjust the delay time between the main sound and sound effect, and each speaker's output level as you wish.

## Delay Time

You can adjust the time difference between the beginning of the sound from the main speakers and the beginning of the sound effect from the rear speakers. The larger the value, the later the sound effect is generated. The delay time can be individually adjusted to all DSP programs.

### Notes

- Adding too much delay will cause an unnatural effect with some sources.
- The sound is momentarily interrupted while adjusting the delay time.

	Program	Preset value (ms)
1.	CONCERT HALL	45
2.	JAZZ CLUB	30
3.	ROCK CONCERT	15
4.	DISCO	26
	5CH STEREO	2
	GAME	36
5.	TV SPORTS	10
6.	MONO MOVIE	69
7.	70 mm SPECTACLE	23
	DGTL SPECTACLE	13
	DTS SPECTACLE	13
	70 mm SCI-FI	20
	DGTL SCI-FI	16
	DTS SCI-FI	16
8.	70 mm ADVENTURE	20
	DGTL ADVENTURE	15
	DTS ADVENTURE	15
	70 mm GENERAL	20
	DGTL GENERAL	15
	DTS GENERAL	15
9.	PRO LOGIC/NORMAL	20
	DOLBY DIGITAL/NORMAL	5
	DTS DIGITAL SUR./NORMAL	5
	PRO LOGIC/ENHANCED	20
	DOLBY DIGITAL/ENHANCED	5
	DTS DIGITAL SUR./ENHANCED	5

## Sound Output Level of the Center, Right Rear and Left Rear Speakers, and Subwoofer

If desired, you can adjust the sound output level of each speaker even if it has already been adjusted in "ADJUSTING THE SPEAKER BALANCE" procedure.

### Notes

- If "CENTER SP" in the SET MENU is set to the NON position, the sound output level of the center speaker cannot be adjusted. This is because the center channel sound is automatically output from the right and left main speakers.
- Once the sound output level has been adjusted, the level will be the same for all DSP programs.

Speaker	Preset value (dB)
Center	0
Right rear	0
Left rear	0
Subwoofer	0

## Adjusting Method

Adjustments should be performed with the remote control while watching the information on the display.

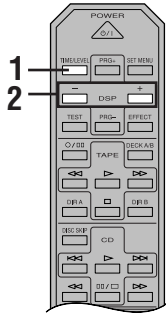

### Notes

- If “CENTER SP” or “REAR LR SP” is set to NON, or “BASS OUT” is set to MAIN, the output level of that speaker cannot be adjusted.
- When you adjust the output level with TIME/LEVEL, the settings you made with the test tone will be changed.
- To adjust speakers other than the subwoofer, the adjusting procedure using test tones on page 19 is recommended.

### Memory back-up

The memory back-up circuit prevents the stored data from being lost when this unit is set in the standby mode. If, however, the power cord is disconnected from the AC power outlet or the power is cut for more than one week, the latest values for the delay time and the center/rear/subwoofer output levels that were set will automatically return to the preset values. If so, adjust the delay time and output levels again.

### 1 Press TIME/LEVEL repeatedly to select the item you want to adjust.

Each time you press TIME/LEVEL, the selected item changes and appears on the display as below.

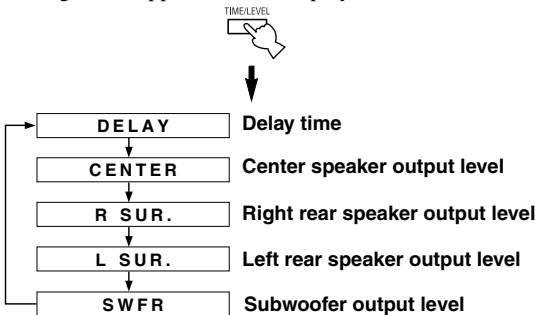

### Note

- Depending on the setting of the SET MENU, you may not be able to select all these items.

### 2 Press – or + to adjust the delay time or speaker output levels.

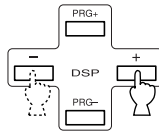

### 3 Repeat steps 1 and 2 to adjust the settings of any other item.



# SLEEP TIMER

The SLEEP timer can be used to automatically set this unit in the standby mode. This timer is useful when you are going to sleep while enjoying a broadcast or other desired input source. The SLEEP timer can only be set with the remote control.

### Note

- The SLEEP timer is effective for the components connected to the AC OUTLET(S) on the rear panel of this unit.

## Setting the SLEEP Timer

**1** Play a source you want to enjoy when you are going to sleep.

**2** Press SLEEP repeatedly to select the desired SLEEP time.



Each time you press SLEEP, the SLEEP time will change as below:

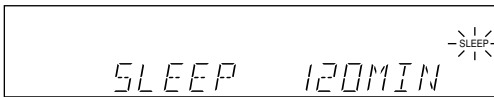
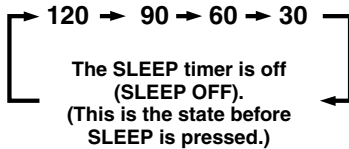

Flashes

**3** The "SLEEP" indicator soon lights up on the display after the SLEEP timer has been set.

The display returns to the previous indication.

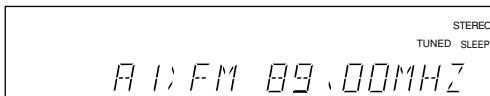

Lights up

## Canceling the SLEEP Timer

**Press SLEEP repeatedly until "SLEEP OFF" appears on the display.**

It will soon disappear and the "SLEEP" indicator will go off.

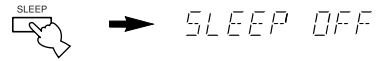

### Note

- The SLEEP timer can also be canceled by setting the unit in the standby mode by using POWER on the remote control (or STANDBY/ON), or by disconnecting the AC power cord from the AC power outlet.



# SOUND FIELD PROGRAM

A digital sound field processor (DSP) based on the latest YAMAHA technology is built into this unit. It is possible to play back various sound fields for the source you are listening to.

## Note

- Regardless of the program name and characteristics listed in the table below, select the sound field program that sounds best to you.

## Hi-Fi DSP Programs

### ■ For audio sources: Nos. 1 to 4

No.	Program (group)	Sub-program	Features
1	CONCERT HALL	—	A large round concert hall with a rich surround effect. Pronounced reflections from all directions emphasize the extension of sounds. The sound field has a great deal of presence, and your virtual seat is near the center, close to the stage.
2	JAZZ CLUB	—	This is the sound field at stage front in “The Bottom Line”, a famous New York jazz club. The floor can seat 300 people to the left and right in a sound field offering a real and vibrant sound.
3	ROCK CONCERT	—	The ideal program for lively, dynamic rock music. The data for this program was recorded at LA’s “hottest” rock club. The listener’s virtual seat is at the center-left of the hall.
4	ENTERTAINMENT	DISCO	This program recreates the acoustic environment of a lively disco in the heart of a big city. The sound is dense and highly concentrated. It is also characterized by a high-energy, “immediate” sound.
		5CH STEREO	Using this program increases the listening position range. This is a sound field suitable for background music at parties.

## Note

- Reverberations (sound effects) for realizing the sound field and unprocessed stereo from the left and right main speakers is output. The sound is not output from the center speaker. (The sound is output when one of these programs is selected while playing a source encoded with a Dolby Digital or DTS signal. If 5CH STEREO is selected, the sound is output from all speakers regardless of the input source.)

## CINEMA DSP Programs

### ■ For audio-video sources: Nos. 4 to 6

No.	Program (group)	Sub-program	Features
4	ENTERTAINMENT	GAME	This program adds a deep and spatial feeling to video game sounds.
5	TV SPORTS	—	Although the presence sound field is relatively narrow, the surround sound field employs the sound environment of a large concert hall. With this program, you can enjoy watching various TV programs such as news, variety shows, music programs or sports programs. In a stereo broadcast of a sports game, the commentator is oriented at the center position, and the shouts and the atmosphere in the stadium spread on the surround side, while their spread to the rear is properly restrained.
6	MONO MOVIE	—	This program is provided for reproducing monaural video sources (such as old movies). The program produces the optimum reverberation to create sound depth by using only the presence sound field.

## ■ For movie programs: Nos. 7 to 9

No.	Program (group)	Sub-program		Input source	Features	
7	MOVIE THEATER 1	SPECTACLE	70 mm SPECTACLE	Analog, PCM, Dolby Digital in 2-channel	This program creates the extremely wide sound field of a 70-mm movie theater. It precisely reproduces the source sound in detail, making both the video and the sound field incredibly real. This is ideal for any kind of video source encoded with Dolby Surround, Dolby Digital or DTS (especially large-scale movie productions).	
			DGTL SPECTACLE	Dolby Digital (5.1-channel)		
			DTS SPECTACLE	DTS		
		SCI-FI	70 mm SCI-FI	Analog, PCM, Dolby Digital in 2-channel		This program clearly reproduces dialog and sound effects in the latest sound form of science fiction films, thus creating a broad and expansive cinematic space amid the silence. You can enjoy science fiction films in a virtual-space sound field that includes Dolby Surround, Dolby Digital and DTS-encoded software employing the most advanced techniques.
			DGTL SCI-FI	Dolby Digital (5.1-channel)		
			DTS SCI-FI	DTS		
8	MOVIE THEATER 2	ADVENTURE	70 mm ADVENTURE	Analog, PCM, Dolby Digital in 2-channel	This program is ideal for precisely reproducing the sound design of the newest 70-mm and multichannel soundtrack films. The sound field is made to be similar to that of the newest movie theaters, so the reverberations of the sound field itself are restrained as much as possible.	
			DGTL ADVENTURE	Dolby Digital (5.1-channel)		
			DTS ADVENTURE	DTS		
		GENERAL	70 mm GENERAL	Analog, PCM, Dolby Digital in 2-channel		This program is for reproducing sounds from 70-mm and multichannel soundtrack films, and is characterized by a soft and extensive sound field. The presence sound field is relatively narrow. It spatially spreads all around and toward the screen, restraining the echo effect of conversations without losing clarity. For the surround sound field, the harmony of music or chorus sounds beautifully in a wide space at the rear of the sound field.
			DGTL GENERAL	Dolby Digital (5.1-channel)		
			DTS GENERAL	DTS		
9	Dolby Digital/DTS SURROUND	NORMAL	PRO LOGIC/NORMAL	Analog, PCM, Dolby Digital in 2-channel	The built-in decoder precisely reproduces sounds and sound effects from sources. The highly efficient decoding process improves crosstalk and channel separation, and makes sound positioning smoother and more precise. In this program, the digital sound field processor is not turned on.	
			DOLBY DIGITAL/NORMAL	Dolby Digital (5.1-channel)		
			DTS DIGITAL SUR./NORMAL	DTS		
		ENHANCED	PRO LOGIC/ENHANCED	Analog, PCM, Dolby Digital in 2-channel		This program ideally simulates the multi-surround speaker systems of the 35-mm film theaters. Dolby Pro Logic decoding, Dolby Digital decoding or DTS decoding and digital sound field processing create precise effects without altering the original sound orientation. The surround effects produced by this sound field wrap around the viewer naturally from the back to the left and right, and toward the screen.
			DOLBY DIGITAL/ENHANCED	Dolby Digital (5.1-channel)		
			DTS DIGITAL SUR./ENHANCED	DTS		

### Notes

- The “” indicator does not light up when selecting the sub-program “NORMAL” of the Dolby Digital/DTS SURROUND program.
- If “CENTER SP” in the SET MENU is set to NON, no sound is output from the center speaker.
- The effect sound is output from the main speakers when a monaural source is played with CINEMA DSP program groups 4 (GAME) and 5 to 8.

## MOVIE THEATER 1 and 2

Most commercially available movie software has 4-channel (left, center, right and surround) sound information encoded by Dolby Surround matrix processing and stored on the left and right tracks. These signals are processed by the Dolby Pro Logic decoder. The MOVIE THEATER programs are designed to recreate the spaciousness and delicate nuances of sound that tend to be lost in the encoding and decoding processes.

The 6-channel soundtracks found on 70-mm film produce precise sound field localization and rich, deep sound without using matrix processing. This unit's MOVIE THEATER 70 mm programs provide the same quality of sound and sound localization that 6-channel soundtracks do.

### When the input source is analog, PCM or encoded with Dolby Digital in 2-channel

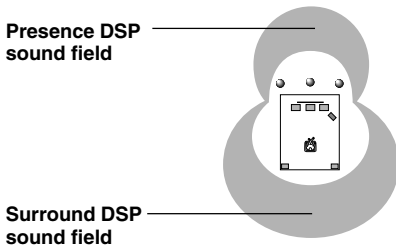

These programs express an immense sound field and a large surround effect. They also give depth to the sound from the main speakers to recreate the realistic sound of a Dolby Stereo theater.

**70 mm SPECTACLE**  
**70 mm SCI-FI**  
**70 mm ADVENTURE**  
**70 mm GENERAL**

The built-in Dolby Digital or DTS decoder brings the professional-quality sound designed for movie theaters into your home. With the unit's MOVIE THEATER programs, you can recreate a dynamic sound that gives you the feeling of being at a public theater in your listening room by using Dolby Digital or DTS technology.

### When the input source is encoded with Dolby Digital (5.1-channel) or DTS (Tri-Field CINEMA DSP)

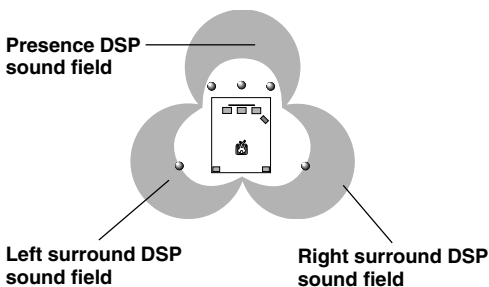

These programs use YAMAHA's tri-field DSP processing on each of the Dolby Digital or DTS signals for the front, left surround and right surround channels. This processing enables this unit to reproduce the immense sound field and surround expression of a Dolby Digital- or DTS-equipped movie theater without sacrificing the clear separation of all channels.

**DGTL SPECTACLE**  
**DTS SPECTACLE**  
**DGTL SCI-FI**  
**DTS SCI-FI**  
**DGTL ADVENTURE**  
**DTS ADVENTURE**  
**DGTL GENERAL**  
**DTS GENERAL**



- If a Dolby Digital signal or DTS signal is input when the input mode is set to AUTO, the DSP program will be automatically switched to the Dolby Digital playback sound field or DTS playback sound field.



# TROUBLESHOOTING

Refer to the chart below when the unit does not function properly. If the problem you are experiencing is not listed below or if the instruction below does not help, set this unit in the standby mode, disconnect the power cord and contact the nearest authorized YAMAHA dealer or service center.

## ■ General

Problem	Cause	Remedy	Refer to page
<b>The unit fails to turn on when STANDBY/ON (or POWER) is pressed, or enters in the standby mode soon after the power has been turned on.</b>	The power cord is not connected or the plug is not completely inserted.	Firmly connect the power cord.	18
	The IMPEDANCE SELECTOR switch on the rear panel is not fully set to the left or right position.	Set the switch fully to the left or right position when the unit is in the standby mode.	18
	The protection circuit has been activated.	Make sure all speaker wire connections on this unit and on all speakers are secure and that the wire for each connection does not touch anything other than its respective connection.	16, 17
<b>No sound and/or no picture.</b>	Incorrect input or output cable connections.	Connect the cables properly. If the problem persists, the cables may be defective.	12 – 15
	An appropriate input source has not been selected.	Select an appropriate input source with INPUT < /> or 6CH INPUT (or the input selector buttons).	21
	The speaker connections are not secure.	Secure the connections.	16, 17
	The main speakers to be used have not been selected properly.	Select the main speakers with SPEAKERS A and/or B.	21
	The volume is turned down.	Turn up the volume.	22
	Digital signals other than PCM audio, Dolby Digital or DTS signal which this unit cannot reproduce are being input to this unit by playing a CD-ROM, etc.	Play a source whose signals this unit can reproduce.	—
<b>The sound suddenly goes off.</b>	The protection circuit has been activated because of a short circuit, etc.	Check the IMPEDANCE SELECTOR switch is set to the appropriate position and then turn the unit back on.	18
		Check the speaker wires are not touching each other and then turn the unit back on.	16, 17
	The sleep timer has functioned.	Turn on the power, and play the source again.	42
<b>Only the speaker on one side can be heard.</b>	Incorrect cable connections.	Connect the cables properly. If the problem persists, the cables may be defective.	12 – 17



Problem	Cause	Remedy	Refer to page
<b>No sound from the effect speakers.</b>	The sound effect is off.	Press EFFECT to turn it on.	25
	A Dolby Surround, Dolby Digital or DTS decoding DSP program is being used with material not encoded with Dolby Surround, Dolby Digital or DTS.	Select another DSP program.	43, 44
<b>No sound from the center speaker.</b>	The output level of the center speaker is set to minimum.	Raise the level of the center speaker.	40
	“CENTER SP” in the SET MENU is set to NON.	Select the appropriate mode for your center speaker.	36
	One of the Hi-Fi DSP programs (1 to 4) has been selected.	Select another DSP program.	43, 44
	The source encoded with a Dolby Digital or DTS signal does not have a center channel signal.		—
<b>No sound from the rear speakers.</b>	The output level of the rear speakers is set to minimum.	Raise the output level of the rear speakers.	40
	A monaural source is being played with the program 9.	Select another DSP program.	43, 44
<b>No sound from the subwoofer.</b>	“BASS OUT” in the SET MENU is set to MAIN when a Dolby Digital or DTS signal is being played.	Select SWFR or BOTH.	37
	“BASS OUT” in the SET MENU is set to SWFR or MAIN when a 2-channel source is being played.	Select BOTH.	37
	The source does not contain low bass signals (90 Hz and below).		—
<b>Poor bass reproduction.</b>	“BASS OUT” in the SET MENU is set to SWFR or BOTH and your system does not include a subwoofer.	Select MAIN.	37
	The output mode for each speaker (main, center or rear) in the SET MENU does not match your speaker configuration.	Select the appropriate output mode for each speaker based on the size of the speakers in your configuration.	36, 37
<b>A “humming” sound can be heard.</b>	Incorrect cable connections.	Firmly connect the audio plugs. If the problem persists, the cables may be defective.	12 – 15

Problem	Cause	Remedy	Refer to page
<b>The volume level cannot be increased, or the sound is distorted.</b>	The component connected to the REC OUT jacks of this unit is turned off.	Turn on the power to the component.	12
<b>The effect and surround sounds cannot be recorded.</b>	It is not possible to record the effect and surround sounds by a recording component.		34
<b>A source cannot be recorded.</b>	A source component is only connected to the digital input jacks of this unit.	Connect the source component to the analog input jacks of this unit.	12 – 15
<b>The settings of the SET MENU and some other settings on this unit cannot be changed.</b>	“9 MEM. GUARD” in the SET MENU is set to ON.	Select OFF.	39
<b>This unit does not operate properly.</b>	The internal microcomputer has been frozen by an external electric shock (such as lightning or excessive static electricity) or by a power supply with low voltage.	Disconnect the AC power cord from the outlet and then plug it in again after about 30 seconds.	—
<b>The sound is degraded when listening with headphones connected to a tape deck or CD player that is connected to this unit.</b>	This unit is in the standby mode.	Turn on the power of the unit.	—
<b>There is noise interference from digital or high-frequency equipment, or the unit.</b>	The unit is too close to the digital or high-frequency equipment.	Move the unit further away from such equipment.	—

## ■ Tuner

	Problem	Cause	Remedy	Refer to page
FM	<b>FM stereo reception is noisy.</b>	The characteristics of FM stereo broadcasts may cause this problem when the transmitter is too far away or the antenna input is poor.	Check the antenna connections. Try using a high-quality directional FM antenna.	26
			Use the manual tuning method.	27
	<b>There is distortion, and clear reception cannot be obtained even with a good FM antenna.</b>	There is multipath interference.	Adjust the antenna position to eliminate multipath interference.	26
	<b>The desired station cannot be tuned in with the automatic tuning method.</b>	The station is too weak.	Use the manual tuning method.	27
			Use a high-quality directional FM antenna.	26
<b>Previously preset stations can no longer be tuned in.</b>	The unit has been disconnected for a long period.	Re-store the stations.	28	
AM	<b>The desired station cannot be tuned in with the automatic tuning method.</b>	The signal is weak or the antenna connections are loose.	Tighten the AM loop antenna connections and orient it for best reception.	26
			Use the manual tuning method.	27
	<b>There are continuous crackling and hissing noises.</b>	Noises result from lightning, fluorescent lamps, motors, thermostats and other electrical equipment.	Use an outdoor antenna and a ground wire. This will help somewhat, but it is difficult to eliminate all noise.	26
	<b>There are buzzing and whining noises (especially in the evening).</b>	A TV set is being used nearby.	Move this unit away from the TV.	—

## ■ Remote control

	Problem	Cause	Remedy	Refer to page
	<b>The remote control does not work nor function properly.</b>	Wrong distance or angle.	The remote control will function within a maximum range of 6 m (20 feet) and no more than 30 degrees off-axis from the front panel.	7
		Direct sunlight or lighting (from an inverter type of fluorescent lamp, etc.) is striking the remote control sensor of this unit.	Reposition the unit.	7
		The batteries are weak.	Replace all batteries with new ones.	3

After this unit has been exposed to a strong external electric shock (such as lightning and strong static electricity) or if you mishandle the operation of this unit, it may not function properly. In these cases, set this unit in the standby mode, disconnect the power cord, plug it back in after 30 seconds, and start operating.



# SPECIFICATIONS

## AUDIO SECTION

- Minimum RMS Output Power for Main, Center, Rear  
20 Hz to 20 kHz, 0.06% THD, 8 ohms ..... 65 W
- Maximum Power  
1 kHz, 0.7% THD, 8 ohms ..... 75 W
- DIN Standard Output Power  
[Europe model only]  
1 kHz, 0.7% THD, 4 ohms ..... 95 W
- IEC Output Power  
[Europe model only]  
1 kHz, 0.06% THD, 8 ohms ..... 67 W
- Damping Factor  
20 Hz to 20 kHz, 8 ohms ..... 60 or more
- Frequency Response  
CD, etc. to Main L/R (1 kHz, 150 mV, 8 ohms)  
..... 20 Hz to 20 kHz,  $\pm 0.5$  dB
- Total Harmonic Distortion  
CD, etc. to Main L/R (Effect Off, 20 Hz to 20 kHz, 30 W, 8 ohms)  
..... 0.025% or less
- Signal to Noise Ratio (IHF-A Network)  
CD, etc. to Main L/R (Effect Off, 250 mV, shorted)  
..... 100 dB or more
- Residual Noise (IHF-A Network)  
Main L/R ..... 150  $\mu$ V or less
- Channel Separation  
CD, etc. to Main L/R (1 kHz) ..... 60 dB  
(10 kHz) ..... 45 dB
- Tone Control (Main L/R)  
BASS Boost/Cut .....  $\pm 10$  dB/50 Hz  
TREBLE Boost/Cut .....  $\pm 10$  dB/20 kHz
- Phones Output ..... 470 mV/390 ohms
- Input Sensitivity  
CD, etc ..... 150 mV/47 kohms  
6CH INPUT ..... 150 mV/47 kohms
- Maximum Input Signal  
CD, etc. (1 kHz, 0.5% THD) ..... 2.2 V or more
- Output Level  
REC OUT ..... 150 mV/1.2 kohms  
SUBWOOFER ..... 4.0 V/1.2 kohms

## VIDEO SECTION

- Video Signal Type ..... PAL
- Composite Video Signal Level ..... 1 Vp-p/75 ohms
- Signal to Noise Ratio ..... 50 dB or more
- Frequency Response (MONITOR OUT)  
Composite ..... 5 Hz to 10 MHz, -3 dB

## FM SECTION

- Tuning Range ..... 87.50 to 108.00 MHz
- Alternate Channel Selectivity ( $\pm 400$  kHz) ..... 70 dB
- Signal to Noise Ratio (IHF)  
Mono/Stereo ..... 76 dB/70 dB
- Harmonic Distortion (1 kHz)  
Mono/Stereo ..... 0.2%/0.3%
- Stereo Separation (1 kHz) ..... 48 dB
- Frequency Response ..... 20 Hz to 15 kHz, +0.5, -2.0 dB

## AM SECTION

- Tuning Range ..... 531 to 1611 kHz
- Usable Sensitivity ..... 300  $\mu$ V/m

## GENERAL

- Power Supply ..... AC 230 V/50 Hz
- Power Consumption ..... 210 W  
Standby Mode ..... 0.96 W
- AC Outlets (Total 100 W maximum)  
[Europe model] ..... 2 (SWITCHED)  
[U.K. model] ..... 1 (SWITCHED)
- Dimension (W x H x D) ..... 435 x 151 x 390 mm
- Weight ..... 9.5 kg
- Accessories ..... Remote Control  
..... Batteries  
..... AM loop antenna  
..... Indoor FM antenna  
..... 75-ohm/300-ohm antenna adapter (U.K. model only)  
..... Connection Guide

\* Specifications are subject to change without notice.



# GLOSSARY

## ■ Dolby Surround

Dolby Surround uses a four analog channel recording system to reproduce realistic and dynamic sound effects: two left and right main channels (stereo), a center channel for dialog (monaural), and a rear channel for special sound effects (monaural). The rear channel reproduces sound within a narrow frequency range.

Dolby Surround is widely used with nearly all video tapes and laser discs, and in many TV and cable broadcasts as well. The Dolby Pro Logic decoder built into this unit employs a digital signal processing system that automatically stabilizes the volume on each channel to enhance moving sound effects and directionality.

## ■ Dolby Digital

Dolby Digital is a digital surround sound system that gives you completely independent multi-channel audio. With three front channels (left, center and right), and two rear stereo channels, Dolby Digital provides five full-range audio channels. With an additional channel especially for bass effects, called LFE (low frequency effect), the system has a total of 5.1 channels (LFE is counted as 0.1 channel). Using two-channel stereo for the rear speakers, more accurate moving sound effects and surround sound environment are possible than with Dolby Surround. The wide dynamic range (from maximum to minimum volume) reproduced by the five full-range channels and the precise sound orientation generated using digital sound processing provide listeners with previously unheard of excitement and realism.

With this unit, any sound environment from monaural up to a 5.1-channel configuration can be freely selected for your enjoyment.

## ■ DTS (Digital Theater Systems) Digital Surround

DTS digital surround was developed to replace the analog soundtracks of movies with a six-channel digital sound track, and is now rapidly gaining popularity in movie theaters around the world. Digital Theater Systems Inc. has developed a home theater system so that you can enjoy the depth of sound and natural spatial representation of DTS digital surround in your home. This system is practically distortion-free, clear 6-channel sound (technically, a left, right and center channels, two rear channels, plus an LFE 0.1 channel as a subwoofer, for a total of 5.1 channels).

## ■ LFE 0.1 channel

This channel is for the reproduction of low bass signals. The frequency range for this channel is 20 Hz to 120 Hz. This channel is counted as 0.1 because it only enforces a low frequency range compared to the full-range reproduced by the other 5 channels in a Dolby Digital or DTS 5.1 channel systems.

## ■ CINEMA DSP

Since the Dolby Surround and DTS systems were originally designed for use in movie theaters, their effect is best felt in a theater having many speakers and designed for acoustic effects. Since home conditions, such as room size, wall material, number of speakers, and so on, can differ so widely, it's inevitable that there are differences in the sound heard as well. Based on a wealth of actually measured data, YAMAHA CINEMA DSP uses YAMAHA original sound field technology to combine Dolby Pro Logic, Dolby Digital and DTS systems to provide the visual and audio experience of movie theater in the listening room of your own home.

## ■ SILENT CINEMA

YAMAHA has developed a natural, realistic sound effect DSP algorithm for headphones. Parameters for headphones have been set for each sound field so that accurate representations of all the sound field programs can be enjoyed on headphones.

## ■ Virtual CINEMA DSP

YAMAHA has developed a virtual CINEMA DSP algorithm that allows you to enjoy DSP sound field surround effects even without any rear speakers by using virtual rear speakers.

It is even possible to enjoy virtual CINEMA DSP in a minimum two-speaker system that does not include a center speaker.

## ■ PCM (Linear PCM)

Linear PCM is a signal format under which an analog audio signal is digitized, recorded and transmitted without using any compression. This is used as a method of recording CDs and DVD audio. The PCM system uses a technique for sampling the size of the analog signal per very small unit of time. Standing for “pulse code modulation”, the analog signal is encoded as pulses and then modulated for recording.

## ■ Sampling frequency and number of quantized bits

When digitizing an analog audio signal, the number of times the signal is sampled per second is called the sampling frequency, while the degree of fineness when converting the sound level into a numeric value is called the number of quantized bits.

The range of rates that can be played back is determined based on the sampling rate, while the dynamic range representing the sound level difference is determined by the number of quantized bits. In principle, the higher the sampling frequency, the wider the range of frequencies that can be played back, and the higher the number of quantized bits, the more finely the sound level can be reproduced.

## ■ I/O ASSIGN (SET MENU)

Although component is normally connected according to jack names shown on the rear panel, this unit includes a function that assigns jacks according to the component being connected. If the component being used differs from the component name shown for this unit’s digital input jacks, it is possible to assign jacks according to the component being connected. This makes it possible to change the jack assignment and effectively connect more component.



# INDEX

<b>A</b>		
AC outlets .....	18	
Antennas .....	26	
<b>B</b>		
BALANCE .....	22	
BGV function .....	22	
<b>C</b>		
CINEMA DSP .....	43, 51	
Connections		
Antennas .....	26	
Audio components (MD recorder, CD recorder and CD player) .....	12	
External decoder .....	12	
Power supply cords .....	18	
Speakers .....	16	
Video components (DVD player, VCR and TV/digital TV or cable TV/satellite tuner) .....	14	
<b>D</b>		
Delay time .....	40	
Display .....	8	
DISPLAY SET (SET MENU)		
DIMMER .....	39	
DOLBY D. SET (SET MENU)		
D-RANGE .....	38	
LFE LEVEL .....	38	
Dolby Digital .....	51	
Dolby Surround (Dolby Pro Logic) .....	51	
DSP program		
CINEMA DSP program .....	43	
Hi-Fi DSP program .....	43	
DTS .....	51	
DTS SET (SET MENU) .....	38	
Dust protection cap .....	12	
<b>E</b>		
External decoder .....	12	
<b>F</b>		
Front panel .....	4	
<b>H</b>		
HP TONE CTRL (SET MENU) .....	37	
<b>I</b>		
IMPEDANCE SELECTOR switch .....	18	
INPUT MODE (SET MENU) .....	38	
Input modes .....	23	
I/O ASSIGN (SET MENU) .....	37, 52	
<b>L</b>		
LFE .....	38, 39, 51	
<b>M</b>		
Memory back-up .....	28, 36, 41	
MEM. GUARD (SET MENU) .....	39	
Muting .....	22	
<b>P</b>		
Package contents .....	3	
PCM .....	52	
Playing .....	21	
Power supply cords .....	18	
Preset stations		
Exchanging preset station .....	30	
Tuning in to a preset station .....	29	
Presetting tuning		
Automatic preset tuning .....	28	
Manual preset tuning .....	29	
<b>R</b>		
RDS stations		
EON function .....	33	
PTY SEEK function .....	32	
RDS mode .....	31	
Rear panel .....	9	
Recording .....	34	
Remote control		
Basic operation .....	6	
Batteries .....	3	
Operation range .....	7	
<b>S</b>		
Sampling frequency .....	52	
SET MENU .....	35	
SILENT CINEMA .....	25, 51	
Sleep timer .....	42	
SP DLY TIME (SET MENU) .....	39	
Speaker		
Output balance (test tone) .....	19	
Output levels (TIME/LEVEL mode) .....	40	
Placement .....	10	
SPEAKER SET (SET MENU)		
BASS OUT .....	37	
CENTER SP .....	36	
MAIN LVL .....	37	
MAIN SP .....	36	
REAR LR SP .....	36	
Subwoofer .....	17	
<b>T</b>		
Test tone .....	19	
Tuning		
Automatic tuning .....	27	
Manual tuning .....	27	
<b>V</b>		
Virtual CINEMA DSP .....	25, 51	



---

**YAMAHA ELECTRONICS CORPORATION, USA** 6660 ORANGETHORPE AVE., BUENA PARK, CALIF. 90620, U.S.A.  
**YAMAHA CANADA MUSIC LTD.** 135 MILNER AVE., SCARBOROUGH, ONTARIO M1S 3R1, CANADA  
**YAMAHA ELECTRONIK EUROPA G.m.b.H.** SIEMENSSTR. 22-34, 25462 RELLINGEN BEI HAMBURG, F.R. OF GERMANY  
**YAMAHA ELECTRONIQUE FRANCE S.A.** RUE AMBROISE CROIZAT BP70 CROISSY-BEAUBOURG 77312 MARNE-LA-VALLEE CEDEX02, FRANCE  
**YAMAHA ELECTRONICS (UK) LTD.** YAMAHA HOUSE, 200 RICKMANSWORTH ROAD WATFORD, HERTS WD1 7JS, ENGLAND  
**YAMAHA SCANDINAVIA A.B.** J A WETTERGRENS GATA 1, BOX 30053, 400 43 VÄSTRA FRÖLUNDA, SWEDEN  
**YAMAHA MUSIC AUSTRALIA PTY, LTD.** 17-33 MARKET ST., SOUTH MELBOURNE, 3205 VIC., AUSTRALIA

**YAMAHA CORPORATION**  
Printed in Malaysia ID V723000



# Connection Guide (when listening to a digital 5.1-channel source)

